

**This document (Annexure-A_Revised) replaces
the original Annexure-A uploaded along with
RfS on 31.12.2022**

F. No. 41/3/2018-SPV Division
Government of India / भारत सरकार
Ministry of New & Renewable Energy / नवीन एवं नवीकरणीय ऊर्जा मंत्रालय

Atal Akshay Urja Bhawan (AAUB),
Lodhi Road, Near CGO Complex
New Delhi –110003
Date: 02-02-2023

Office Memorandum

Subject: Updated Specification and Testing Procedures for the Solar Photovoltaic (SPV) Water Pumping System and Universal Solar Pump Controller (USPC).

Ministry has issued specifications and testing procedure for the solar PV water pumping systems and USPC to be used in the agriculture sector on 17.07.2019. So far, the specifications for the solar PV water pumping systems had been issued for a capacity upto 10 HP. Requests have been received from various stakeholders for providing specifications for pumps of capacity more than 10 HP. Further, based on implementation in the field certain feedbacks were received and clarification on some of the issues from the stakeholders. Accordingly, Ministry has prepared specifications for Solar PV water pumping systems for capacity up to 25 HP alongwith the testing procedure and updated the existing specifications and testing procedures including that of USPC to provide more clarity during implementation. These specifications and testing procedures are hereby issued for the information of all concerned and are attached as various Annexures as under:

- i) Specification for the SPV water pumping system. (Annexure-A)
- ii) Testing procedure for the SPV water pumping system. (Annexure-B)
- iii) USPC specification and testing procedure. (Annexure-C)



(J K Jethani)
Scientist-F/Sr. Director

To:
All concern.

SPECIFICATION FOR SOLAR PHOTOVOLTAIC WATER PUMPING SYSTEMS

1. SCOPE

These specification covers design qualifications and performance specifications for Centrifugal Solar Photo Voltaic (SPV) Water Pumping Systems from 1HP (0.75kW) to 25 HP (18.75 kW) suitable for bore-well, open well, water reservoir, water stream, etc., and specifies the minimum standards to be followed under MNRE Schemes.

2. TERMINOLOGY

In addition to the terminology specified in 3 of IS 5120 and IEC 62253, the following shall also apply.

2.1 Static Water Depth — It is the depth of water level below the ground level when the pump is not in operation.

2.2 Draw-Down — It is the elevation difference between the depth of static water level and the consistent standing water level in the bore-well during the operation the of pump set.

2.3 Submergence — It is the minimum height of the water level after drawdown above the pump suction casing.

2.4 Manometric Suction Lift — Manometric suction lift is the vacuum gauge/suction manometer reading in the meter of the water column when the pump operates at suction lift.

2.5 Suction Lift — Suction lift/head is the vertical distance be the ween sump water level and center of Surface Mono-set inlet.

2.6 Daily Water Output — It is the total water output on a clear sunny day with three times tracking SPV panel, under the “Average Daily Solar Radiation” condition of 7.15 KWh / m² on the surface of SPV array (i.e., coplanar with the SPV Modules).

2.6 Wire to Water Efficiency — It is the combined system efficiency of SPV Module, Converter/Controller with Inbuilt MPPT mechanism, Pump set and piping.

2.7 Pump Controller — Pump Controller converts the DC voltage of the SPV array into a suitable DC or AC, single or multi-phase power and may also include equipment for MPPT, remote monitoring, and protection devices.

2.8 Maximum Power Point Tracker (MPPT) — MPPT is an algorithm that is included in the pump controller used for extracting maximum available power from SPV array under a given condition. The voltage at which SPV array can produce maximum power is called 'maximum power point' voltage (or peak power voltage).

3. CONSTRUCTIONAL FEATURES

3.1 General

3.1.1 SPV Water Pumping System set uses the irradiance available through SPV array. The SPV array produces DC power, which can be utilized to drive a DC or an AC pump set using pump controller.

3.2 A SPV Water Pumping system typically consists of:

3.2.1 Motor Pump Set see 3.4.

3.2.2 SPV Controller

Note: Some controllers are inbuilt in the motors

Specifications of Controller/Drive for Solar Water Pumping Systems

S.No.	Requirement	Specifications
1.	<i>Controller Power Capacity to drive the Pump</i>	Controller Power Capacity should be at-least equal to Solar Panels Power Capacity (Wp), not Pump Capacity. Example: For 5HP pumps, the pump capacity will be 3750W as per MNRE Specs, the solar panel capacity will be at-least 4800Wp the controller capacity should match the solar panel capacity.
2.	<i>Point Tracking (MMPT)</i>	Should track power only and not Voltage at Maximum power point
3.	<i>Enclosure</i>	The Controller with RMS must have IP65 protection.
4.	<i>Isolator Switch</i>	Should be between Solar panels and the controller
5.	<i>RMS (GSM/GPRS connectivity)</i>	Controller shall be integrated with Remote Monitoring System with GSM/GPRS and Geo tagging. GSM/ GPRS Charges are to be included in the Costing till the end the of the Warranty period of the Pump set.

6.	Controller display/screen	The various parameters should be present on the SPV Pump Controller display/screen such as:- Pump On/Off status, Array Input DC Voltage, DC/AC output Current & voltage, operating frequency, Latest RMS Latitude, Latest RMS Longitude, Pump Capacity (HP), PV Module Capacity (KW), Pump Status, Current Generation (kW), Today Solar Generation (kWh), Cumulative Solar Generation (kWh), Today Runs Hours (Hrs.), Cumulative Pump Run Hours (Hrs.), Cumulative Water Discharged (Litres), Total Water Discharged (Litres), Peak Power (kW) supplied by the controller to Motor-Pump Set.
----	---------------------------	--

For IS 16221 (Part-2) certification of the SPV pump controller the latest quality control order released by MNRE regarding IS 16221 (Part-2) must be followed.

3.2.2.1 Remote Monitoring System (RMS)

The detailed Specification of RMS is attached at Annexure I.

3.3 Solar Photo Voltaic (SPV) Array

3.3.1 SPV arrays contains required number of PV modules of similar type and specifications, connected in series or parallel to obtain the required voltage or current output. The SPV water pumping system should be operated with a PV array of minimum capacity in the range of **900 Wp to 22500Wp**, measured under Standard Test Conditions (STC). A Sufficient number of modules in series and parallel could be used to obtain the required voltage or current output. The power output of individual PV modules used in the SPV array, under STC, should be a minimum of **300 Wp**, with adequate provision for tolerances measurement. Use of PV modules with higher power output is preferred.

3.3.2 Modules supplied with the SPV water pumping systems shall have a certificate as per IS 14286/IEC 61215 specifications or equivalent National or International /Standards. Lab certified STC performance data supplied with the modules shall not be more than one year old.

3.3.3 Modules must qualify to IS/IEC 61730 Part I and II for safety qualification testing.

3.3.4 The minimum module efficiency should be minimum 19 percent and fill factor shall be more than 75 percent.

3.3.5 Modules must qualify to IEC TS 62804-1:2015 for the detection of potential-induced degradation - Part 1: Crystalline silicon (Mandatory in case the SPV array Open Circuit voltage is more than 600 V DC)

3.3.6 In case the SPV water pumping systems are intended for use in coastal areas the solar modules must qualify to IEC TS 61701:2011 for salt mist corrosion test.

3.3.7 The name plate shall conform to IS 14286/IEC 61215.

3.3.8 Module to Module wattage mismatch in the SPV array shall be within ± 3 percent.

3.3.9 Any array capacity above the minimum array wattage requirement as specified in these specifications for various models of solar pumping systems is allowed.

3.3.10 The PV Modules must be warranted for output wattage, which should not be less than 90% of the rated wattage at the end of 10 years and 80% of the rated wattage at the end of 25 years.

3.3.11 The RFID tag shall be placed on the SPV Modules inside the glass laminate.

3.4 Motor-Pump Set

3.4.1 The SPV water pumping systems may use any of the following types of motor pump sets:

- a) Surface Mono-set
- b) Submersible motor-pump set.
- c) Any other type of the motor pump set after approval from Ministry.

3.4.2 Motor

The motors of the pump set may be of the following types: -

- a) AC Induction Motor.
- b) DC Motor (PMSM/BLDC/SRM)

3.4.3 The “Motor-Pump Set” should have a capacity in the range of 1 HP (0.75 kW) to 25 HP (18.75kW) and should have the following features:

- a) The closed coupled or mono block DC/ AC centrifugal motor pump set with appropriate mechanical seals which ensures ensure zero leakage.
- b) The motor of the capacity ranging from 1 HP to 25 HP should be AC/DC. The suction and delivery head will depend on the site-specific condition of the field.
- c) Submersible pumps could also be used according to the dynamic head of the site at which the pump is to be used.

3.4.4 The pump and all external parts of the motor used in the submersible pump which are in contact with water, should be of stainless steel of grade 304 or higher as required. Further for submersible pumps used in coastal areas or bores with higher salinity, stainless steel of grade 316 or a higher grade may be used.

3.4.5 Total Harmonic Distortion (THD) of the AC output waveform of the inverter at the motor input of the motor-pump set shall be less than or equal to 10 % and further no individual harmonic shall exceed the limit of 6 %. For checking its compliance it should be done as per IS 16221.

3.4.6 The suction/ delivery pipe shall be of HDPE or uPVC column pipes of appropriate size, electric cables, floating assembly, civil work, and other fittings required to install the Motor Pump set. In the case of HDPE pipes the minimum pressure rating of 8 kg/sqcm-PE100 grade for pump sets up to 3 HP, 10 kg/sqcm-PE100 grade for 5 HP pump set and further higher minimum pressure rating for above 5 HP as appropriate shall be used.

3.5 Module Mounting Structures and Tracking System

3.5.1 The PV modules should be mounted on metallic structures of adequate strength and appropriate design, which can withstand the load of modules and high wind velocities up to 150 km per hour. The raw material used and the process for manufacturing of module mounting structure including welding of joints should conform to applicable IS 822. The module mounting structure should be hot dip galvanized according to IS 4759. Zinc content in working area of the hot dip galvanizing bath should not be less than 99.5% by mass.

3.5.2 In order to make the structure rigid, the gap between Telescopic pattern supports should be minimal, further, for bearing of center load of whole structure only pins should be used instead of threaded bolts. To enhance the performance of SPV water pumping systems arrangement for seasonal tilt angle adjustment and three times manual tracking in a day should be provided. In order to make structure rigid, the gap between Telescopic pattern supports should be minimal, further, for bearing of center load of whole structure only pins should be used instead of threaded bolts.

3.5.3 The general hardware for structure fitment should be either SS 304 or 8.8 grade. Modules should be locked with antitheft bolts of SS 304 Grade. Foundation should be as per the site condition, based on the properties of soil. Foundation can be done either with the help of 'J Bolt' (refer to IS 5624 for foundation hardware) or direct piling, it should be decided as per the site and relevant IS i.e., IS 6403 / 456 / 4091 / 875 should be referred for foundation design.

3.5.4 Details of Module Mounting Structure (MMS) for pumps of capacity 1HP and above are attached at Annexure-II. These are indicative of minimum standards and an Implementing Agency may specify higher standards which shall be certified by the recognized structural engineering department of any IIT/NIT or IISC. The format of the certificate is placed at Annexure-III.

3.6 SPV Controller

3.6.1 Maximum Power Point Tracker (MPPT) shall be included to optimally use the power available from the SPV array and maximize the water discharge.

3.6.2 The SPV Controller with RMS must have **IP65** protection.

3.6.3 Adequate protections shall be provided in the SPV Controller to protect the solar powered pump set against the following:

- a) Dry running;
- b) Open circuit;
- c) Output short circuit;
- d) Under voltage;
- e) Reverse polarity;

3.6.4 Static MPPT efficiency of controller shall be equal or more than 98% during operation of 10 to 100% of rated STC PV power, and average MPPT tracking efficiency in the dynamic condition should be greater than 97 % with hot and cold profiles. To ascertain the above requirement, controller shall be tested as per the procedure laid down by MNRE for testing of USPC with respect to the water pumping load only.

3.6.5 A DC switch as per IS/IEC 60947-1 & 2 suitable for switching dc power ON and OFF shall be provided in the SPV Pump Controller.

3.6.6 All cables used shall be as per IS 694 or IS 9968(Part 1). Suitable size of cable shall be used in sufficient length for inter-connection between the SPV array to SPV Controller and the SPV Controller to solar powered pump set. Selection of the cable shall be as per IS 14536.

3.6.7 The various parameters should be present on the SPV Pump Controller display/screen such as:- Pump On/Off status, Array Input DC Voltage, DC/AC output Current & voltage, operating frequency, Latest RMS Latitude, Latest RMS Longitude, Pump Capacity (HP), PV Module Capacity (KW), Pump Status, Current Generation (kW), Today Solar Generation (kWh), Cumulative Solar Generation (kWh), Today Runs Hours (Hrs.), Cumulative Pump Run Hours (Hrs.), Cumulative Water Discharged (Litres), Total Water Discharged (Litres), Peak Power (kW) supplied by the controller to Motor-Pump Set.

3.7 Protections

The system should be provided with all necessary protections like earthing, Lightning, and Surge Protection etc., as described below:

3.7.1 Earthing and Lightning Protection

- 1) The Earthing shall be done in accordance with the IS 3043 including its amendments and updated versions.
- 2) The Earthing system should be designed in such a way that its should able to restrict the potential of each conductor according to the level of insulation applied and magnitude of the current conducted through human body should be less than the value that can cause ventricular fibrillation of heart.
- 3) Earth connections shall be done in such a way that they are visible for inspection and all the earth electrodes can easily be tested at any point of time.
- 4) It is recommended to keep the value of resistance of earth electrode less than 5 ohms.
- 5) All the materials, fittings etc. used for doing earthing shall conform to the Indian standard, wherever exists.
- 6) The actual value of soil resistivity should be considered while designing the earthing system at the site and for reference, selection criteria of the site, for any type of soil treatment to improve earth electrode resistance, etc. the IS 3043 shall be referred.
- 7) The electrode material should be selected according to the corrosivity of the soil in which it is used, for the relation between resistivity and corrosivity of the soil and method to safeguard the conductor against excessive corrosion the IS 3043 shall be referred.
- 8) It is recommended for selection of type and installation of the earth electrode the provisions of the IS 3043 should be considered. However, the pipe or rod-type earth electrode is preferable.
- 9) In case of the two-earth electrode or more the separation among them should be twice the length of the electrode driven in the ground. Except in special conditions (for e.g.- where the soil is hard to dig out), a number of electrodes in parallel are to be preferred to a single long electrode.
- 10) The provisions given in the IS 3043 should be considered while selecting or connecting the earthing/protective/grounding conductor from the components to the earth pit.
- 11) Separate earthing conductor shall be provided for the controller, pump-motor set and SPV array etc. for its connection to the earthing pit and it should be continuous in nature for electrical conductivity. However, even for the earthing of light current equipment (for example, high voltage testing equipment) the cross-sectional area of the earthing lead shall not be less than 6 mm².
- 12) For the maintenance of the earth electrode and measurement of the Earth electrode resistance the provisions of IS 3043 shall be referred.
- 13) Motor shall have suitable provision for earthing to facilitate earthing of the motor as per IS 3043 at the time of installation. In case GI pipes are used for the purpose of earthing the motor, an earthing connection may be made to the discharge pipe clamps. However, in case of HDPE/PVC pipes, a separate metallic cable from the motor to the control panel shall be

provided and earthing given as if a four-core cable is used, the fourth core not connected to the terminals can be used for earthing.

- 14) Lightning protection shall be provided as per IEC 62305 and IEC 63227 standards including its amendments and updated versions.
- 15) An external lightning Rod, whose height should be more than the highest point in the system with a lightning protection system (LPS) designed to comply with class III or higher shall be installed, based on the site requirement which in turn depends on the area-specific lightning activity, etc. parameters.
- 16) Arrangement and positioning of the separate air-termination systems can be determined using different methods given in the IEC 62305-3. While determining the position following points are to be considered such as: -
 - a) The structure to be protected is fully located within the protected volume provided by the air-termination system.
 - b) There should be separation distance between the air-termination system and PV power supply system to prevent dangerous sparking against parts of the PV power supply system in case of direct lightning. The separation distances determined in accordance with IEC 62305-3 & IEC 63227 shall preferably be maintained.
 - c) The possibility of the PV modules being shadowed by air-termination systems shall be taken into account and distance from the PV modules can be calculated using the IEC 63227.
- 17) A separate earth electrode is required for the dispersion of the lightning current into the ground with suitably low value of the earthing resistance i.e., less than 5 ohm. And the minimum length (l_1) of vertical earth electrodes for lightning protection level III or higher shall be determined according to the IEC 62305-3.
- 18) The cross-section of the metal sub-structures used for the connection of the lightning arrestor to the earth electrode should be no less than 16 mm² Cu or 25 mm² Al or GI of equivalent current carrying capacity should be used, which will also depend upon the class of the Lightning protection system.
- 19) The earth pits given with the SWPS {i.e., Earth pit(s) for the BoS system (other than LA) and Earth Pit for LA} should be made equipotential bonded to each other.

3.7.2 Surge Protection Device

- 1) For SPDs IEC 63227 and its updated versions or amendments should be followed.
- 2) At the DC Input side of the controller, it should have protection from an External Surge Protection Device of Type-2 or higher (i.e., Type-1) in accordance with the IEC 61643-31.
- 3) If the distance between the SPD and the Pump controller to be protected is greater than 10 m, then SPD according to IEC 63227 should be applied.
- 4) The rated voltage of SPDs on the DC side depends on the type of protective circuit and the magnitude of the maximum operating voltage of the PV modules.

3.8 Use of indigenous components

It will be mandatory to use indigenously manufactured solar modules with indigenous mono/multi-crystalline silicon solar cells. Further, the motor-pump-set, controller and balance of system should also be manufactured indigenously. The vendor has to declare the list of imported components used in the solar water pumping system.

4 PERFORMANCE REQUIREMENTS

4.1 Under the “Average Daily Solar Radiation” condition of 7.15kWh / sq.m. on the surface of PV array (i.e., coplanar with the PV Modules), the minimum water output from a Solar PV Water Pumping System at different “Total Dynamic Heads” should be as specified below:

For D.C. Motor Pump Set:

- i) 110 liters of water per watt peak of PV array, from a Total Dynamic Head of 10 meter (Suction head, if applicable, minimum of 7 meter static suction lift corrected for atmospheric pressure and water temperature) and with the shut off head being at least 12 meter.
- ii) 55 liters of water per watt peak of PV array, from a Total Dynamic Head of 20 meter (Suction head, if applicable, minimum of 7-meter static suction lift corrected for atmospheric pressure and water temperature) and with the shut off head being at least 25 meter.
- iii) 38 liters of water per watt peak of PV array, from a Total Dynamic Head of 30 meters (Suction head, if applicable, minimum of 7-meter static suction lift corrected for atmospheric pressure and water temperature) and the shut off head being at least 45 meter.
- iv) 23 liters of water per watt peak of PV array, from a Total Dynamic Head of 50 meter (Suction head, if applicable, minimum of 7-meter static suction lift corrected for atmospheric pressure and water temperature) and the shut off head being at least 70 meter.
- v) 15 liters of water per watt peak of PV array, from a Total Dynamic Head of 70 meters (Suction head, if applicable, minimum of 7-meter static suction lift corrected for atmospheric pressure and water temperature) and the shut off head being at least 100 meter.
- vi) 10.5 liters of water per watt peak of PV array, from a Total Dynamic Head of 100 meters (Suction head, if applicable, minimum of 7-meter static suction lift corrected for atmospheric pressure and water temperature) and the shut off head being at least 150 meter.

- vii) 9.5 liters of water per watt peak of PV array, from a Total Dynamic Head of 120 meters (Suction head, if applicable, minimum of 7-meter static suction lift corrected for atmospheric pressure and water temperature) and the shut off head being at least 180 meter.
- viii) 7.5 liters of water per watt peak of PV array, from a Total Dynamic Head of 150 meters (Suction head, if applicable, minimum of 7-meter static suction lift corrected for atmospheric pressure and water temperature) and the shut off head being at least 225 meter.
- ix) 5.5 liters of water per watt peak of PV array, from a Total Dynamic Head of 200 meters (Suction head, if applicable, minimum of 7-meter static suction lift corrected for atmospheric pressure and water temperature) and the shut off head being at least 300 meter.
- x) 4.5 liters of water per watt peak of PV array, from a Total Dynamic Head of 250 meters (Suction head, if applicable, minimum of 7-meter static suction lift corrected for atmospheric pressure and water temperature) and the shut off head being at least 375 meter.

The actual duration of pumping of water on a particular day and the quantity of water pumped could vary depending on the solar intensity, location, season, etc.

Indicative performance specifications for the Shallow and Deep well SPV Water Pumping Systems are attached at Annexure IV.

For A.C. Induction Motor Pump Set:

- i) 99 liters of water per watt peak of PV array, from a Total Dynamic Head of 10 meter (Suction head, if applicable, minimum of 7-meter static suction lift corrected for atmospheric pressure and water temperature) and with the shut off head being at least 12 meter.
- ii) 49 liters of water per watt peak of PV array, from a Total Dynamic Head of 20 meter (Suction head, if applicable, minimum of 7-meter static suction lift corrected for atmospheric pressure and water temperature) and with the shut off head being at least 25 meter.
- iii) 35 liters of water per watt peak of PV array, from a Total Dynamic Head of 30 meter (Suction head, if applicable, minimum of 7-meter static suction lift corrected for atmospheric pressure and water temperature) and the shut off head being at least 45 meter.
- iv) 21 liters of water per watt peak of PV array, from a Total Dynamic Head of 50 meter (Suction head, if applicable, minimum of 7-meter static suction lift corrected for

atmospheric pressure and water temperature) and the shut off head being at least 70 meter.

- v) 14 liters of water per watt peak of PV array, from a Total Dynamic Head of 70 meter (Suction head, if applicable, minimum of 7-meter static suction lift corrected for atmospheric pressure and water temperature) and the shut off head being at least 100 meter.
- vi) 9 liters of water per watt peak of PV array, from a Total Dynamic Head of 100 meter (Suction head, if applicable, minimum of 7-meter static suction lift corrected for atmospheric pressure and water temperature) and the shut off head being at least 150 meter.
- vii) 8.5 liters of water per watt peak of PV array, from a Total Dynamic Head of 120 meters (Suction head, if applicable, minimum of 7-meter static suction lift corrected for atmospheric pressure and water temperature) and the shut off head being at least 180 meter.
- viii) 6.7 liters of water per watt peak of PV array, from a Total Dynamic Head of 150 meters (Suction head, if applicable, minimum of 7-meter static suction lift corrected for atmospheric pressure and water temperature) and the shut off head being at least 225 meter.
- ix) 5.0 liters of water per watt peak of PV array, from a Total Dynamic Head of 200 meters (Suction head, if applicable, minimum of 7-meter static suction lift corrected for atmospheric pressure and water temperature) and the shut off head being at least 300 meter.
- x) 4.0 liters of water per watt peak of PV array, from a Total Dynamic Head of 250 meters (Suction head, if applicable, minimum of 7-meter static suction lift corrected for atmospheric pressure and water temperature) and the shut off head being at least 375 meter.

The actual duration of pumping of water on a particular day and the quantity of water pumped could vary depending on the solar intensity, location, season, etc.

Indicative performance specifications for the Shallow and Deep well SPV Water Pumping Systems are attached at Annexure V.

5 TESTS FOR HYDRAULIC AND ELECTRICAL PERFORMANCE OF PUMPSET

5.1 The AC motor-pump set shall be tested independently for hydraulic and electrical performance as per the relevant IS specification including the following test

- a) Constructional requirements/features
- b) General requirements
- c) Design features
- d) Insulation resistance test

- e) High voltage test
- f) Leakage current test

In case of the DC motor-pump set for (a), (b), (c) declaration will be given by the vendor and for (d), (e), (f) the relevant clause of IS 9283:2013 will be followed for testing until BIS notifies the Standard about it. Once the Standard gets released then it will be effective for DC motor-pump set from its Date of notification.

5.2 Testing of SPV Water Pumping Systems shall be done as per the procedure specified by the MNRE.

6 GUARANTEE OF PERFORMANCE

6.1 The SPV Water Pumping Systems shall be guaranteed for their performance of the nominal volume rate of flow and the nominal head at the guaranteed duty point as specified in 7.1 under the “Average Daily Solar Radiation” condition of 7.15 kWh/m² on the surface of SPV array (i.e., coplanar with the Photo Voltaic (PV) Modules). The actual duration of pumping of water on a particular day and the quantity of water pumped could vary depending on the solar intensity, location, season, etc.

6.2 Solar Photo Voltaic Water Pumping Systems shall be guaranteed by the manufacturer against the defects in material and workmanship under normal use and service for a period of at least 60 months from the date of commissioning.

6.3 Sufficient spares for trouble free operation during the Warrantee period should be made available as and when required

7 MARKING AND PARAMETERS TO BE DECLARED BY THE MANUFACTURER

7.1 The motor pump-set and Controller used in SPV Water Pumping Systems shall be securely marked with the following parameters declared by the manufacturer:

7.1.1 Motor Pump-set

- a) Manufacturer's name, logo or trade-mark;
- b) Model, size and SI No of pump-set (To be engraved/laser marked on the motor frame);
- c) Motor Rating (kW / HP);
- d) Total head, m, at the guaranteed duty point;
- e) Capacity (LPD) at guaranteed head;
- f) Operating head range, m;
- g) Maximum Current (A);
- j) Voltage Range (V) and;
- k) Type - AC or DC Pump set; &

- l) Photo Voltaic (PV) Array Rating in Watts peak (W_p)
- m) Country of origin

Note: -In addition, a metal name plate containing the above details shall be fixed on the module mounting structure for the information of user.

7.1.2 Controller

- a) Manufacturer's name, logo or trade-mark;
- b) Model Number;
- c) Serial Number;
- d) Voltage Range;
- e) Power Range in kW for Controller; and
- f) Current rating (A)
- g) Country of origin

8 OPERATION AND MAINTENANCE MANUAL

8.1 An Operation and Maintenance Manual, in English and the local language, should be provided with the solar PV water pumping system. The Manual should have information about solar energy, photovoltaic, modules, DC/AC motor pump set, tracking system, mounting structures, electronics and switches. It should also have clear instructions about mounting of PV module, DO's and DONT's and on regular maintenance and Trouble Shooting of the pumping system. Helpline number, Name and address of the Service Centre and contact number of authorized representative to be contacted in case of failure or complaint should also be provided. A warranty card for the modules and the motor pump set should also be provided to the beneficiary.

9 COMPREHENSIVE OPERATION AND MAINTENANCE

- i. The Contractor should provide 5 years comprehensive maintenance of the Solar Photovoltaic Water pumping system set, which shall include corrective maintenance as well as routine service visits during CMC period.
- ii. CMC shall be in line with scheme guidelines and its amendment (if any). Apart from the monitoring, regular periodical maintenance of system has to be done. The report has to be maintained in a prescribed format containing Month, Inspection Date, Action taken against the Defects found in the System and along with signatures of both service Engineer and the farmer/ beneficiary. Maintenance report in digital form to be sent to Scheme implementing agency (SIA) and also uploaded on the portal of SIA whenever such portal or mobile app is made available.

- iii. The deputed personnel shall be in a position to check and test all the equipments regularly, so that preventive actions, if any, could be taken well in advance to save any equipment from damage.

- iv. Normal and preventive maintenance of the Solar Photovoltaic Water pumping systems such as cleaning of module surface, tightening of all electrical connections, changing of tilt angle of module mounting structure, cleaning & greasing of motor pump sets, changing filters etc. are also the duties of the deputed personnel during maintenance visits.

- v. During the operation and maintenance period of the Solar Photovoltaic Water Pumping Systems, if there is any loss or damage of any component due to miss management or miss handling or due to any other reasons pertaining to the deputed personnel by empaneled vendor, what-so-ever, the supplier shall be responsible for immediate replacement or rectification. The damaged component may be repaired or replaced by a new component.

- vi. The maintenance shall include replacement of any component irrespective of whether the defect was a manufacturing defect or due to wear and tear.

LIST OF REFERRED INDIAN STANDARDS

456:2000	Plain and reinforced concrete - Code of practice (Fourth Revision)
811:1987	Specification for cold formed light gauge structural steel sections (Second Revision)
822:1970	Code of procedure for inspection of welds
IS 875: Part 1: 1987	Code of practice for design loads (Other Than Earthquake) for buildings and structures: Part 1 dead loads - Unit weights of building materials and stored materials (Second Revision)
694:2010	Polyvinyl Chloride Insulated Unsheathed--And Sheathed Cables/cords With Rigid And-Flexible Conductor for Rated Voltages-Up To And Including 450/750 V
1079:2017	Hot rolled carbon steel sheet, plate and strip - Specification (Seventh Revision)
1161:2014	Steel tubes for structural purposes - Specification (Fifth Revision)
1239 (Part 1):2004	Steel tubes, tubulars and other wrought steel fittings - Specification: Part 1 steel tubes (Sixth Revision)
2062:2011	Hot rolled medium and high tensile structural steel - Specification (Seventh Revision)
2629:1985	Recommended practice for hot-dip galvanizing of iron and steel (First Revision)
2633:1986	Method for testing uniformity of coating on zinc coated articles (Second Revision)
3043:1987	Code of Practice for Earthing
4091:1979	Code of practice for design and construction of foundations for transmission line towers and poles (First Revision)
4759:1996	Hot - Dip zinc coatings on structural steel and other allied products - Specification (Third Revision)
5120:1977	Technical requirements for rotodynamic special purpose pumps (First revision)
5624:1993	Foundation bolts - Specification (First Revision)
6403:1981	Code of practice for determination of bearing capacity of shallow foundations
6745:1972	Methods for determination of mass of zinc coating on zinc coated iron and steel articles
7215:1974	Tolerances for fabrication of steel structures
8034:2018	Submersible pump sets - Specification (third revision)
9079:2018	Monoset pumps for clear, cold water for agricultural and water supply purposes - Specification (third revision)
9283:2013	Motors for submersible pump sets
9968 (Part 1):1988	Specification for elastomer insulated cables: Part 1 for working voltages up to and including 1100 volts (First Revision)
14220:2018	Open well submersible pump sets - Specification (first revision)
14536:2018	Selection, installation, operation and maintenance of submersible pumpset - Code of practice (First Revision)
IS/IEC61701: 2011	Salt mist corrosion testing of photovoltaic (PV) modules First Revision

IS 17210 (Part 1): 2019 IEC TS 62804-1 : 2015	Photovoltaic (PV) Modules — Test Methods for the Detection of Potential-Induced Degradation Part 1 Crystalline Silicon
IS/IEC 60034-1:2004	Rotating Electrical Machines — Part 1 Rating and Performance
IS/IEC 61683:1999	Photovoltaic System-Power Conditioners — Procedure for Measuring Efficiency
IEC 62253:2011	Photovoltaic Pumping Systems – Design qualification and performance measurements
IS 14286: 2010 /IEC 61215 : 2005	Crystalline Silicon Terrestrial Photovoltaic (Photo Voltaic (PV)) modules - Design Qualification and Type Approval (First Revision)
IS/IEC 61730-1: 2004	Photovoltaic (Photo Voltaic (PV)) Module Safety Qualification Part 1 Requirements for Construction
IS/IEC 61730-2: 2004	Photovoltaic (Photo Voltaic (PV)) Module Safety Qualification Part 2 Requirements for Testing
IEC 60068-2-6:2007	Environmental testing – Part 2-6: Tests – Test Fc: Vibration (sinusoidal)
IEC 60068-2-30:2005	Environmental testing – Part 2-30: Tests – Test Db: Damp heat, cyclic (12 + 12h cycle)
IS 16221 (Part-2)	Safety of Power Converters for use in Solar Photovoltaic Power Systems
IEC 62305-1/2/3/4	Lightning Protection
IEC 63227	Lightning and Surge Voltage Protection for photovoltaic (PV) power supply systems
IEC 61643-31	Low-voltage surge protective devices
IS/IEC 60947: PART 1: 2007	Low - Voltage switchgear and control gear: Part 1 general rules (First Revision)
IS xxxxxx (Doc No MED/20/13071)	Solar Photovoltaic Water Pumping Systems — Testing Procedure Guidelines

Specifications for Remote Monitoring System (RMS)

The Remote Monitoring System shall be capable of providing and handling the following:

- a. Solar System Performance: DC Voltage, DC current, AC output Current, Power, Drive frequency, Energy, etc.
- b. Pump Performance: Running Hours, Water Discharge (Output), etc.
- c. RMS Performance: %Device Connectivity, %Data Availability, etc.
- d. Geo Location: Real time latitude and longitude should be captured with an accuracy of less than 10m horizontal.
This is required to ensure that system is not moved from its original location.
- e. Events and Notifications: Faults related to Pump Operation, Solar generation, Controller/Drive faults like overload, dry run, short circuit, etc.
- f. Consumer Management: Name, Agriculture details, Service No. Contact Details, etc.
- g. Asset Management: Ratings, Serial Number, Make, Model Number of Pump, Panel and Controller, Geo Location, IMEI number (of communication module) and ICCID (of SIM).
- h. Complaint and Ticket Management: Complaint management system is a part of centralized monitoring software platform.
- i. Consumer Mobile Application: Generation, Running Hours, Water Discharge, Complaint logging, etc.

Communication Architecture of the RMS should be as mentioned below:

a. Communication Connectivity:

- i. **Pump Controller Connectivity:** Communication between RMS and Pump Controller should be on UART/RS485 MODBUS RTU protocol to ensure interoperability irrespective of make and manufacturer.
- ii. **Remote Connectivity:** RMS of SWPS should be using GSM/GPRS/2G/3G/4G cellular connectivity.
- iii. **Local Connectivity:** Ethernet/Bluetooth/Wi-Fi connectivity to configure parameters, notifications, communication interval, set points etc. or to retrieve locally stored data
- iv. **Sensor Connectivity:** RMS should have provision for at least two Analog and Digital inputs with 0.1% accuracy to address the requirement of local sensors connectivity if required by SIA/Consumer for applications such as irradiation, flow meter for water discharge, moisture sensor for micro-irrigation, etc.

As mentioned in specifications, Analog and digital sensor inputs will be required for integration of flow meter for water discharge, moisture sensor for micro irrigation, level sensor for overhead tank water storage etc. Only provision for Analog and digital inputs with

0.1% accuracy of Full-Scale Range is required. Sensors will not be in scope of bidder.

- v. RMS should have provision to give various modes of operations which are as follows:
 - i. Remote Mode: - Pump can be made ON/Off using the Mobile App or in case, farmer do not have a smart phone, farmer shall be able to on-off pump thru SMS/missed call.
 - ii. Auto Mode: - Pump can ON/Off automatically using the sensor data which are installed in the field by the beneficiary. (Cost of sensors will be worn by the beneficiary)
 - iii. Timer Mode: - Pump controller shall operate pump as per configured schedule using mobile application i.e.,daily start time and running hours of pump.
 - iv. Manual Mode: - Pump can be made to run into manual mode from field.

To save ground water, provision for remote operation is required so that farmer can switch on and off remotely.

b. Communication Modes:

- i. Push Data on Event/Notification: such as pump on, pump off, protection operated, etc.
- ii. Push Data Periodically: important parameters of solar pump (as mentioned above) should be pushed to central server on a configurable interval. **Default interval should be of 15 minutes. However, if required, it should be possible to configure the periodic interval in multiple of 1 minute starting from 1 minute and up to 15 minutes. Further, in case of any abnormalities or events, RMS should push on event immediately.**
- iii. Command on Demand: It should be possible to send commands via GSM or GPRS to RMS either to control pump operations or to update configuration.

c. Communication Protocol: RMS should provide data on MQTT protocol to establish communication with thousands of systems.

d. Security:

- i. Communication between RMS and Server should be secured and encrypted using TLS/SSL/X.509 certificate etc.
- ii. As a part of IoT protocol, Authentication and Authorization should be implemented using a token/password mechanism

- e. **Message Format:** RMS should provide data in a JSON message format as per requirement of implementing agency.
- f. **Data Storage:** In case of unavailability of cellular network, RMS should store data locally and on availability of network it should push data to the central Server. Local data storage should be possible for one year in case of unavailability of a cellular network. RMUs should have configuration updates over the Air of multiple parameters such as IP, APN, Data logging Interval, Set Points etc. is essential. Software updating should be possible with 2G and even without the presence of SD card. Software updating process and/or failure to update software shouldn't disrupt pumping operations.

RMS should be connected to the Solar Energy Data Management Platform of the implementing Agency.

- g. RMUs should have configuration updates over the Air of multiple parameters such as IP, APN, Data logging Interval, Set Points etc. is essential. Software to be updated through "Programming over the air" on SIA server. Software updating process and/or failure to update software shouldn't disrupt pumping operations.

Manufacturer should consider Programming Over the Air (POTA) instead of Firmware Over the Air (FOTA) to update configurable parameters such as server IP, URL, Port, APN, Periodic Interval etc.

**Specifications for Dual Axis Manual Tracking Type
Module Mounting Structure (MMS) for Solar Water Pumping System**

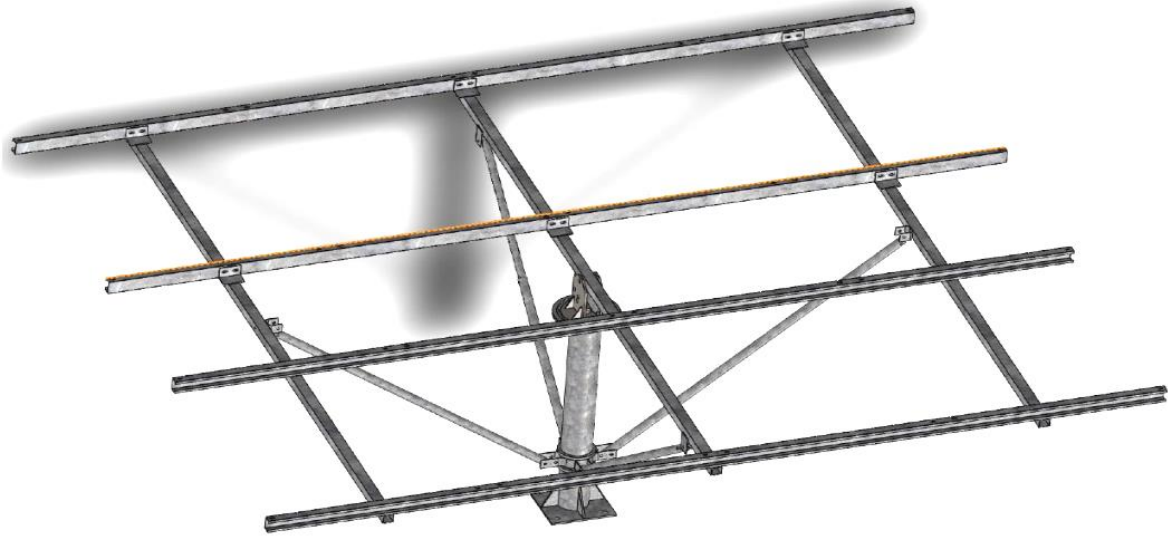

4 Module MMS



6 Module MMS

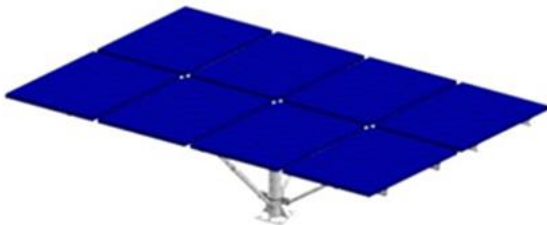

8 Module MMS



10 Module MMS

A-1 Standard MMS for 4, 6, 8 and 10 solar modules have been specified. These standard MMS may be used in combinations for different capacities of solar water pumping systems as follows:

1. Standard MMS of 4 Modules for 1 HP
 2. Standard MMS of 6 Modules for 2 HP
 3. Standard MMS of 10 Modules or Combination of standard MMS of 4 Modules and standard MMS 6 Modules for 3 HP
 4. Combination of two standard MMS of 8 Modules or combination of standard MMS of 10 Modules and standard MMS 6 Modules for 5 HP
 5. Combination of three standard MMS of 8 Modules or combination of two standard MMS of 10 Modules and one standard MMS 6 Modules for 7.5 HP
- and so on....

A- 2 Specifications of the main parts used in MMS are given below:

A-2.1 Centre Shaft

Centre shaft used in structure shall be of:

- a) For 4, 6 and 8 Modules structure - minimum 139 OD with a minimum thickness of 4 mm with base plate minimum 10 mm thickness if used and foundation hardware shall be as per IS 5624.
- b) For 10 Modules structure - minimum 165 OD with a minimum thickness of 4 mm with base plate minimum 20 mm thickness if used and foundation hardware shall be as per IS 5624.

For a system without a base plate i.e., direct piling is shall be as per the site condition based on the properties of Soil and refer (IS 6403 / 456 / 4091 / 875) for foundation design.

A-2.2Rafters

The Main and secondary rafter used in the structure shall be of either SHS & RHS pipe sections.

A-2.3Purlin

Mounting Purlins used in the structure shall be made of Cold form steel section as per IS 1079 with a minimum thickness of 2 mm.

A-2.4 Provision for Seasonal Tilt

In one structure at least four telescopic supports (three may be used in MMS for 4 modules) either round hollow sections or square hollow sections to be provided to support the mounting structure.

A-2.5 Provision for Daily Tracking

Provision for Daily tracking shall be provided by the way of providing min. 8 mm thick metal sheet with precision cut grooves.

A-2.6 Module Locking System

Modules shall be locked with antitheft bolts of SS 304 Grade.

A-2.7General Hardware for Structure Fitment

Either SS 304 or 8.8 grade hardware shall be used for fitment.

A-2.8Hot Dip Galvanizing

All structure parts shall be hot dip galvanized according to IS 4759.

A-2.9Tolerance for Fabrication

Tolerance for fabrication of steel structure shall as per IS 7215.

A-2.10Welding

Welding shall be done as per IS: - 822 & grade of welding wire shall be (ER70S-6).

A-2.11 Raw Material Test Certificates (MTC)

MTC of all types of raw material used in dual-axis manual tracking type MMS as per appropriate Indian Standards shall be submitted along with dispatch documents.

A-2.12 Square washer to be used for all the nut-bolts arrangement.

A-2.13 Tests to be performed on Dual Axis Manual Tracking Type MMS for Solar Water Pumping System.

A-2.13.1 For ascertaining proper welding of structure part following shall be referred.

- a) Weld wire grade shall be of grade **(ER 70 S - 6)**; and
- b) D.P. Test (Pin Hole / Crack) **(IS 822)**

A-2.13.2 For ascertaining hot dip galvanizing of fabricated structure following shall be referred: -

- a) Min coating required shall be as per IS 4759.
- b) Testing of galvanized material.
- c) PREECE Test (CuSO₄ Dip Test) **(IS 2633)**
- d) Mass of Zinc **(IS 6745 or IS 4759)**
- e) Adhesion Test **(IS 2629)**

A-2.14 Due to the use of the higher capacity SPV Modules for the Solar Photovoltaic Water Pumping System the size and weight of each SPV module changes wrt to the lower capacity module. Therefore, the appropriate changes should be made in the MMS design which is to be used with the higher capacity modules such that the stress on the individual structural members shall not exceed the stresses in the corresponding member as specified in the MNRE specification.

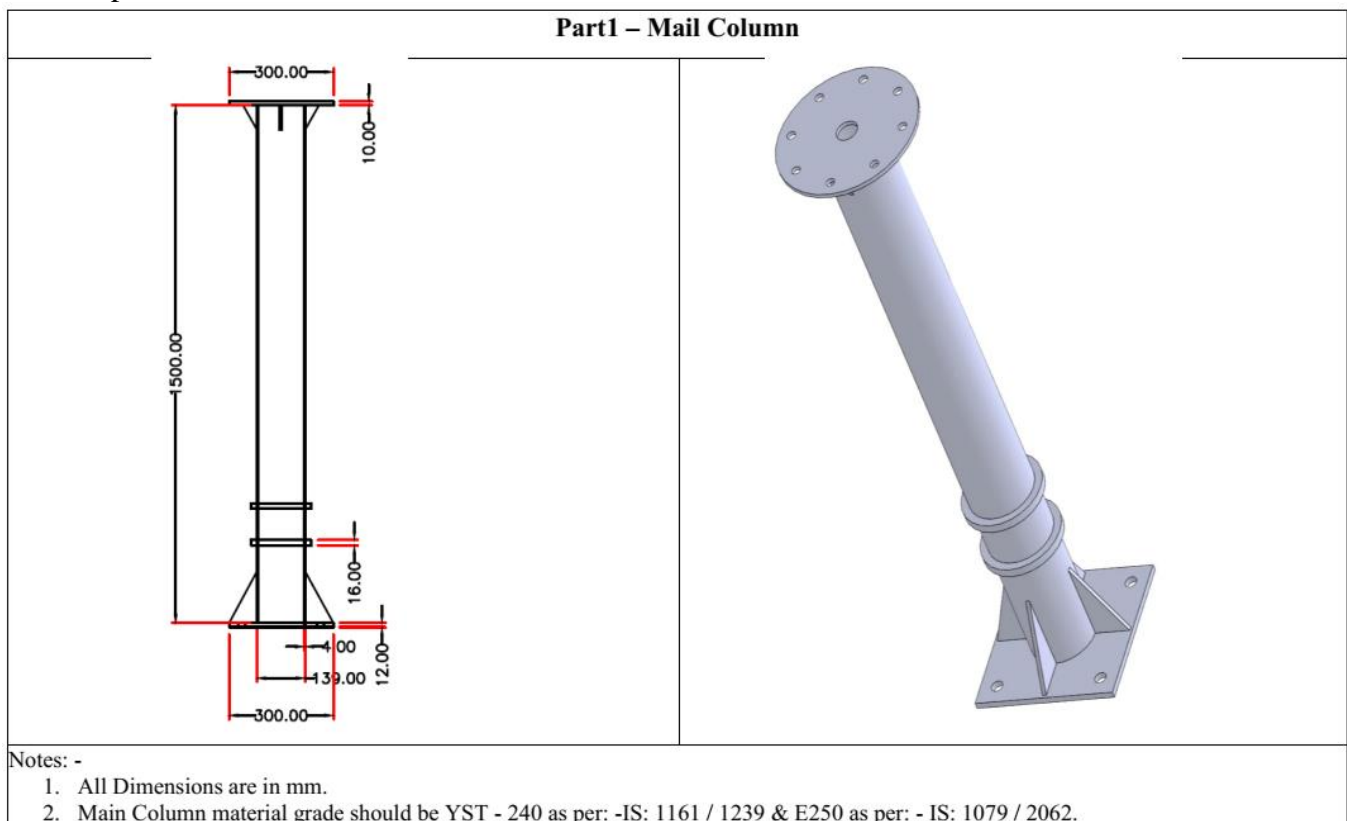

Part 2 – Top Plate

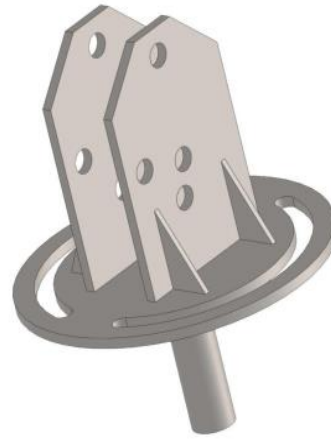
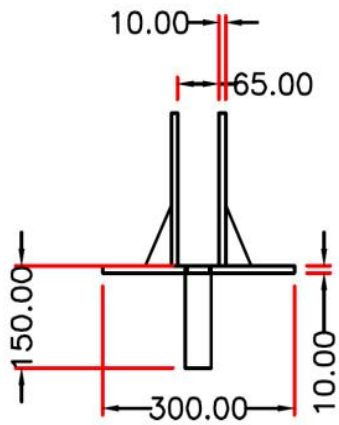

Notes: -

1. All Dimensions are in mm.
2. Top Plate material grade should be YST - 240 as per: -IS: 1161 / 1239 & E250 as per: - IS: 1079 / 2062.

Part 3 – Main Tube

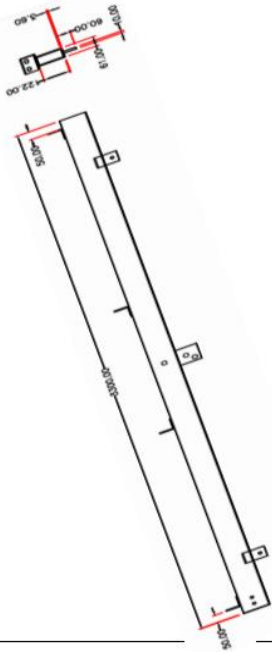

Notes: -

1. All Dimensions are in mm.
2. Main Tube material grade should be YST - 240 as per: -IS: 1161 / 1239 & E250 as per: - IS: 1079 / 2062.

Part 4 – Side Tube

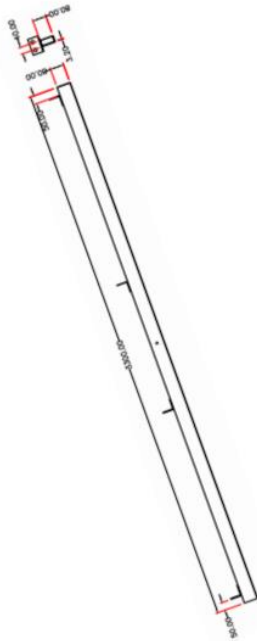

Notes: -

1. All Dimensions are in mm.
2. Side Tube material grade should be YST - 240 as per: -IS: 1161 / 1239 & E250 as per: - IS: 1079 / 2062.

Part 5 – Purlin



Notes: -

1. All Dimensions are in mm.
2. Mounting Purlin material grade should be E250 as per: - IS: 1079 / 2062 & IS: 811.

Part 6 – Clamp with Blade

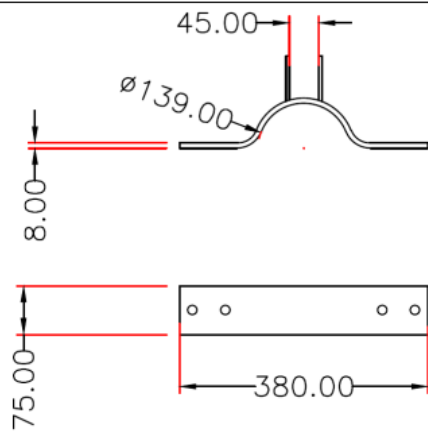

Notes: -

1. All Dimensions are in mm.
2. Clamp with Blade material grade should be as per: - IS: 1079 & E250 as per: - IS: 2062.

Part 7 – Supporting Pipes

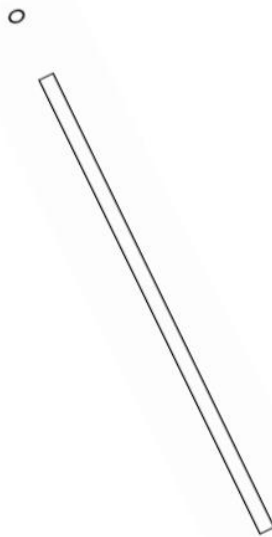

Notes: -

1. All Dimensions are in mm.
2. Supporting Pipes material grade should be YST - 240 as per: -IS: 1161 / 1239 & E250 as per: - IS: 1079 / 2062.

Main Parts of MMS for Solar Water Pumping System

SR. NO.	PART NAME	CROSS SECTION DETAIL	LENGTH (MM)	QUANTITY PER SET
1.	MAIN POLE			
	4, 6 and 8 Modules	139 OD	1500	1
	10 Modules	165 OD	1500	1
2.	TOP PLATE (Common for all)	300 OD	--	1
3.	CLAMP WITH BLADE			
	4, 6 and 8 Modules (for 139 OD pole)	75X8	380	2
	10 Modules (for 165 OD pole)	75X8	380	2
4.	SUPPORTING PIPES			
	4, 6 and 8 Modules	41 OD & 33 OD	--	6
	10 Modules	41 OD & 33 OD	--	8
5.	MAIN TUBE			
	4 and 6 Modules	60X60X3.6	3300	1
	8 and 10 Modules	122X61X3.6	3300	1
6.	SIDE TUBE			
	4 and 6 Modules	50X50X3.6	3300	2
	8 and 10 Modules	80X40X3.2	3300	2
7.	MOUNTING PURLIN			
	4 Modules	80X50X15X2	2050	4
	6 Modules	80X50X15X2	3100	4
	8 Modules	80X50X15X2	4150	4
	10 Modules	100X50X15X2	5200	4

FOUNDATION DESIGN FOR 4/6 MMS

BOM				
TMT BAR	LENGTH	WEIGHT	QUANTITY	TOTAL WEIGHT
16 MM	1000 MM	1.578 KG	8 PCS	12.6 KG
8 MM	2400 MM	0.950 KG	4 PCS	3.8 KG
8 MM	1250 MM	0.500 KG	4 PCS	2 KG

BOM				
BLOCK	WIDTH	LENGTH	HEIGHT	VOLUME
RCC COLUMN	0.600 M	0.600 M	0.900 M	0.324 CU.M
PCC	0.900 M	0.900 M	0.200 M	0.162 CU.M

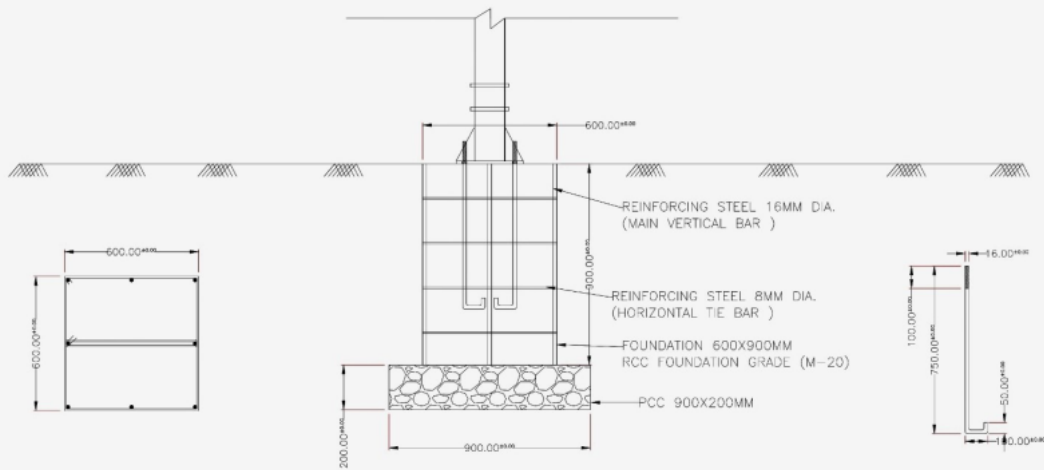

Note: All dimensions are critical & in mm. Please maintain the dimensions. Welding dimension should be maintained 5 mm.

FOUNDATION DESIGN FOR 8 MMS

BOM				
TMT BAR	LENGTH	WEIGHT	QUANTITY	TOTAL WEIGHT
16 MM	1300 MM	2.05 KG	8 PCS	16.4 KG
8 MM	2400 MM	0.950 KG	6 PCS	5.7 KG
8 MM	1250 MM	0.500 KG	6 PCS	3 KG

BOM				
BLOCK	WIDTH	LENGTH	HEIGHT	VOLUME
RCC COLUMN	0.600 M	0.600 M	1.20 M	0.432 CU.M
PCC	0.900 M	0.900 M	0.200 M	0.162 CU.M

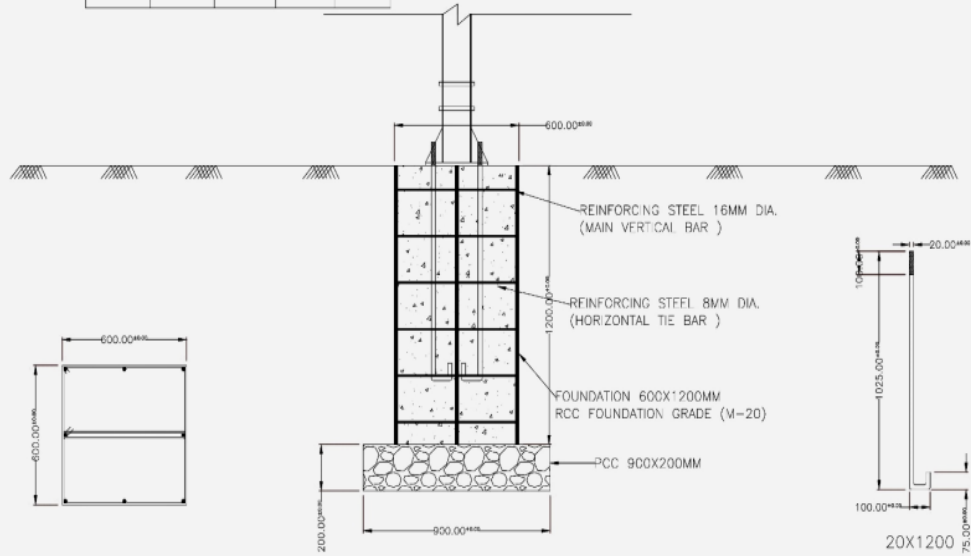

Note: All dimensions are critical & in mm. Please maintain the dimensions. Welding dimension should be maintained 5 mm.

FOUNDATION DESIGN FOR 10 MMS

BOM				
TMT BAR	LENGTH	WEIGHT	QUANTITY	TOTAL WEIGHT
16 MM	1600 MM	2.50 KG	8 PCS	20 KG
8 MM	3200 MM	1.25 KG	7 PCS	8.75 KG
8 MM	1650 MM	0.65 KG	7 PCS	4.55 KG

BOM				
BLOCK	WIDTH	LENGTH	HEIGHT	VOLUME
RCC COLUMN	0.800 M	0.800 M	1.50 M	0.960 CU.M
PCC	1.20 M	1.20 M	0.200 M	0.288 CU.M

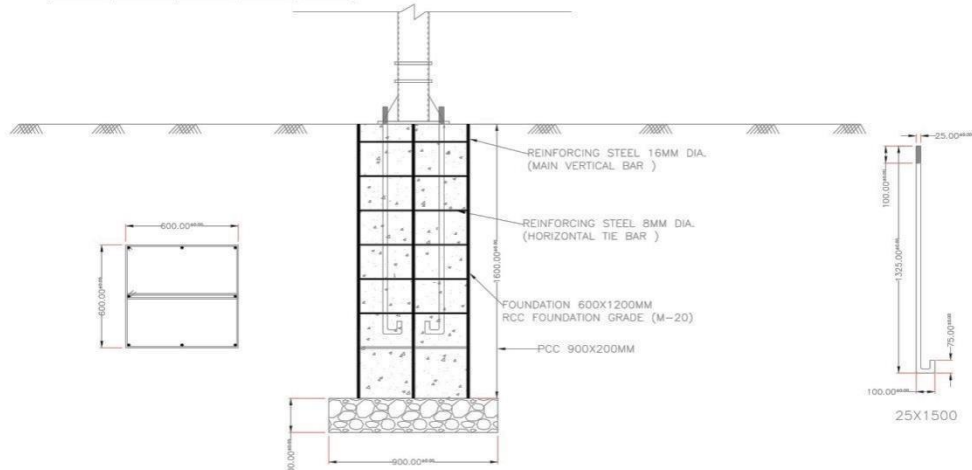

Note:-All dimensions are critical & in mm. Please maintain the dimensions. Welding dimension should be maintained 5 mm.

Format of Certificate by the Structural Engineering Department for MMS

(To be submitted on the letterhead of the Department/College)

This is to certify that the MMS structure drawing along with the foundation(copy enclosed) supplied by.....(Vendor Name) is evaluated at our structural Engineering Department facility at.....(College Name) and it is found superior(in terms of the structural integrity/ load bearing capacity/ stress on the individual structural member) to the MMS structure along with foundation specified in the Specification of Solar Water Pumping System notified by the Ministry of New and Renewable Energy (MNRE) vide **F.No-41/3/2018-SPV Division dated 02.02.2023.**

The following are the changes when compared to the MNRE’s MMS suggestive design: -

S.No.	According to the MNRE MMS	According to the vendor MMS

These are the following improvements in the MMS design submitted by the vendor over the MNRE’s MMS suggestive design: -

- 1.
- 2.

Note:- The lab may attach drawings/calculations wherever needed

Signature of the head (Structural engineering department)

ANNEXURE – IV

Indicative Technical Specifications of Shallow Well (Surface) Solar Pumping Systems with D.C. Motor Pump Set with Brushless.

Description	Model-1	Model-2	Model-3	Model-4	Model-5	Model-6	Model-7	Model-8	Model-9	Model-10	Model-11	Model-12	Model-13
PV array (Wp)	900	1800	2700	2700	4800	4800	4800	6750	6750	6750	9000	9000	9000
Motor Pump-set capacity (HP)	1	2	3	3	5	5	5	7.5	7.5	7.5	10	10	10
Shut Off Dynamic Head (meters)	12	12	12	25	12	25	45	12	25	45	12	25	45
Water output * (Liters per day)	99000 (from a total head of 10 meters)	198000 (from a total head of 10 meters)	297000 (from a total head of 10 meters)	148500 (from a total head of 20 meters)	528000 (from a total head of 10 meters)	264000 (from a total head of 20 meters)	182400 (from a total head of 30 meters)	742500 (from a total head of 10 meters)	371250 (from a total head of 20 meters)	256500 (from a total head of 30 meters)	990000 (from a total head of 10 meters)	495000 (from a total head of 20 meters)	342000 (from a total head of 30 meters)

* Water output figures are on a clear sunny day with three times tracking of SPV panel, under the “Average Daily Solar Radiation” condition of 7.15 kWh/ sq.m. on the surface of PV array (i.e. coplanar with the PV Modules).

Notes:

1. Suction head, if applicable, minimum 7 meters.
2. For higher or lower head / PV capacity, or in between various models; water output could be decided as per the clause 4 (i.e. Performance Requirements) specified earlier.
3. If submersible pumps are used in lieu of surface pumps, the water output must match that of the surface pumps as specified in this table.

ANNEXURE – IV (CONTD.)

Indicative Technical Specifications of Shallow Well (Surface) Pumping Systems with D.C. Motor Pump Set with Brushless.

Description	Model-14	Model-15	Model-16	Model-17	Model-18	Model-19	Model-20	Model-21	Model-22	Model-23	Model-24	Model-25	Model-26
PV array (Wp)	11250	11250	11250	11250	13500	13500	13500	13500	15750	15750	15750	18000	18000
Motor Pump-set capacity (HP)	12.5	12.5	12.5	12.5	15	15	15	15	17.5	17.5	17.5	20	20
Shut Off Dynamic Head (meters)	12	25	45	70	25	45	70	100	45	70	100	45	70
Water output * (Liters per day)	1237500 (from a total head of 10 meters)	618750 (from a total head of 20 meters)	427500 (from a total head of 30 meters)	258750 (from a total head of 50 meters)	742500 (from a total head of 20 meters)	513000 (from a total head of 30 meters)	310500 (from a total head of 50 meters)	202500 (from a total head of 70 meters)	598500 (from a total head of 30 meters)	362250 (from a total head of 50 meters)	236250 (from a total head of 70 meters)	684000 (from a total head of 30 meters)	414000 (from a total head of 50 meters)

* Water output figures are on a clear sunny day with three times tracking of SPV panel, under the “Average Daily Solar Radiation” condition of 7.15 kWh/ sq.m. on the surface of PV array (i.e. coplanar with the PV Modules).

Notes:

1. Suction head, if applicable, minimum 7 meters.
2. For higher or lower head / PV capacity, or in between various models; water output could be decided as per the clause 4 (i.e. Performance Requirements) specified earlier.
3. If surface pumps are used in lieu of submersible pumps, the water output must match that of the submersible pumps as specified in this table.

Indicative Technical Specifications of Shallow Well (Surface) Pumping Systems with D.C. Motor Pump Set with Brushless.

Description	Model-27	Model-28	Model-29	Model-30	Model-31	Model-32	Model-33	Model-34
PV array (Wp)	18000	18000	20250	20250	20250	22500	22500	22500
Motor Pump-set capacity (HP)	20	20	22.5	22.5	22.5	25	25	25
Shut Off Dynamic Head (meters)	100	150	70	100	150	70	100	150
Water output * (Liters per day)	270000 (from a total head of 70 meters)	189000 (from a total head of 100 meters)	465750 (from a total head of 50 meters)	303750 (from a total head of 70 meters)	212625 (from a total head of 100 meters)	517500 (from a total head of 50 meters)	337500 (from a total head of 70 meters)	236250 (from a total head of 100 meters)

* Water output figures are on a clear sunny day with three times tracking of SPV panel, under the “Average Daily Solar Radiation” condition of 7.15 kWh/ sq.m. on the surface of PV array (i.e. coplanar with the PV Modules).

Notes:

1. Suction head, if applicable, minimum 7 meters.
2. For higher or lower head / PV capacity, or in between various models; water output could be decided as per the clause 4 (i.e. Performance Requirements) specified earlier.
3. If surface pumps are used in lieu of submersible pumps, the water output must match that of the submersible pumps as specified in this table

ANNEXURE – IV (CONTD.)

Indicative Technical Specifications of Solar Deep well (submersible) Pumping Systems with D.C. Motor Pump Set with Brushless.

Description	Model-1	Model-2	Model-3	Model-4	Model-5	Model-6	Model-7	Model-8	Model-9	Model-10	Model-11	Model-12	Model-13	Model-14
PV array (Wp)	1200	1800	3000	3000	3000	4800	4800	4800	6750	6750	6750	9000	9000	9000
Motor Pump-set capacity (HP)	1	2	3	3	3	5	5	5	7.5	7.5	7.5	10	10	10
Shut Off Dynamic Head (meters)	45	45	45	70	100	70	100	150	70	100	150	70	100	150
Water output * (Liters per day)	45600 (from a total head of 30 meters)	68400 (from a total head of 30 meters)	114000 (from a total head of 30 meters)	69000 (from a total head of 50 meters)	45000 (from a total head of 70 meters)	110400 (from a total head of 50 meters)	72000 (from a total head of 70 meters)	50400 (from a total head of 100 meters)	155250 (from a total head of 50 meters)	101250 (from a total head of 70 meters)	70875 (from a total head of 100 meters)	207000 (from a total head of 50 meters)	135000 (from a total head of 70 meters)	94500 (from a total head of 100 meters)

* Water output figures are on a clear sunny day with three times tracking of SPV panel, under the “Average Daily Solar Radiation” condition of 7.15 kWh/ sq.m. on the surface of PV array (i.e. coplanar with the PV Modules).

Notes:

1. Suction head, if applicable, minimum 7 meters.
2. For higher or lower head / PV capacity, or in between various models; water output could be decided as per the clause 4 (i.e. Performance Requirements) specified earlier.
3. If submersible pumps are used in lieu of surface pumps, the water output must match that of the surface pumps as specified in this table.

ANNEXURE – IV (CONTD.)

Indicative Technical Specifications of Solar Deep well (submersible) Pumping Systems with D.C. Motor Pump Set with Brushless.

Description	Model-15	Model-16	Model-17	Model-18	Model-19	Model-20	Model-21	Model-22	Model-23	Model-24	Model-25	Model-26	Model-27	Model-28
PV array (Wp)	11250	11250	11250	11250	13500	13500	13500	13500	15750	15750	15750	15750	18000	18000
Motor Pump-set capacity (HP)	12.5	12.5	12.5	12.5	15	15	15	15	17.5	17.5	17.5	17.5	20	20
Shut Off Dynamic Head (meters)	100	150	180	225	100	150	180	225	100	150	180	225	150	180
Water output * (Liters per day)	168750 (from a total head of 70 meters)	118125 (from a total head of 100 meters)	106875 (from a total head of 120 meters)	84375 (from a total head of 150 meters)	202500 (from a total head of 70 meters)	141750 (from a total head of 100 meters)	128250 (from a total head of 120 meters)	101250 (from a total head of 150 meters)	236250 (from a total head of 70 meters)	165375 (from a total head of 100 meters)	149625 (from a total head of 120 meters)	118125 (from a total head of 150 meters)	189000 (from a total head of 100 meters)	171000 (from a total head of 120 meters)

* Water output figures are on a clear sunny day with three times tracking of SPV panel, under the “Average Daily Solar Radiation” condition of 7.15 kWh/ sq.m. on the surface of PV array (i.e. coplanar with the PV Modules).

Notes:

1. Suction head, if applicable, minimum 7 meters.
2. For higher or lower head / PV capacity, or in between various models; water output could be decided as per the clause 4 (i.e. Performance Requirements) specified earlier.
3. If submersible pumps are used in lieu of surface pumps, the water output must match that of the surface pumps as specified in this table.

ANNEXURE – IV (CONTD.)

Indicative Technical Specifications of Solar Deep well (submersible) Pumping Systems with D.C. Motor Pump Set with Brushless.

Description	Model-29	Model-30	Model-31	Model-32	Model-33	Model-34	Model-35	Model-36	Model-37	Model-38	Model-39
PV array (Wp)	18000	18000	20250	20250	20250	20250	20250	22500	22500	22500	22500
Motor Pump-set capacity (HP)	20	20	22.5	22.5	22.5	22.5	22.5	25	25	25	25
Shut Off Dynamic Head (meters)	225	300	150	180	225	300	375	180	225	300	375
Water output * (Liters per day)	135000 (from a total head of 150 meters)	99000 (from a total head of 200 meters)	212625 (from a total head of 100 meters)	192375 (from a total head of 120 meters)	151875 (from a total head of 150 meters)	111375 (from a total head of 200 meters)	91125 (from a total head of 250 meters)	213750 (from a total head of 120 meters)	168750 (from a total head of 150 meters)	123750 (from a total head of 200 meters)	101250 (from a total head of 250 meters)

* Water output figures are on a clear sunny day with three times tracking of SPV panel, under the “Average Daily Solar Radiation” condition of 7.15 kWh/ sq.m. on the surface of PV array (i.e. coplanar with the PV Modules).

Notes:

1. Suction head, if applicable, minimum 7 meters.
2. For higher or lower head / PV capacity, or in between various models; water output could be decided as per the clause 4 (i.e. Performance Requirements) specified earlier.
3. If submersible pumps are used in lieu of surface pumps, the water output must match that of the surface pumps as specified in this table.

ANNEXURE – V

Indicative Technical Specifications of Shallow Well (Surface) Solar Pumping Systems with A.C. Induction Motor Pump Set

Description	Model-1	Model-2	Model-3	Model-4	Model-5	Model-6	Model-7	Model-8	Model-9	Model-10	Model-11	Model-12	Model-13
PV array (Wp)	900	1800	2700	2700	4800	4800	4800	6750	6750	6750	9000	9000	9000
Motor Pump-set capacity (HP)	1	2	3	3	5	5	5	7.5	7.5	7.5	10	10	10
Shut Off Dynamic Head (meters)	12	12	12	25	12	25	45	12	25	45	12	25	45
Water output * (Liters per day)	89100 (from a total head of 10 meters)	178200 (from a total head of 10 meters)	267300 (from a total head of 10 meters)	132300 (from a total head of 20 meters)	475200 (from a total head of 10 meters)	235200 (from a total head of 20 meters)	168000 (from a total head of 30 meters)	668250 (from a total head of 10 meters)	330750 (from a total head of 20 meters)	236250 (from a total head of 30 meters)	891000 (from a total head of 10 meters)	441000 (from a total head of 20 meters)	315000 (from a total head of 30 meters)

* Water output figures are on a clear sunny day with three times tracking of SPV panel, under the “Average Daily Solar Radiation” condition of 7.15 kWh/ sq.m. on the surface of PV array (i.e. coplanar with the PV Modules).

Notes:

1. Suction head, if applicable, minimum 7 meters.
2. For higher or lower head / PV capacity, or in between various models; water output could be decided as per the clause 4. (i.e. Performance Requirements) specified earlier.
3. If submersible pumps are used in lieu of surface pumps, the water output must match that of the surface pumps as specified in this table.

ANNEXURE –V (CONTD.)

Indicative Technical Specifications of Shallow Well (Surface) Solar Pumping Systems with A.C. Induction Motor Pump Set

Description	Model-14	Model-15	Model-16	Model-17	Model-18	Model-19	Model-20	Model-21	Model-22	Model-23	Model-24	Model-25	Model-26
PV array (Wp)	11250	11250	11250	11250	13500	13500	13500	13500	15750	15750	15750	18000	18000
Motor Pump-set capacity (HP)	12.5	12.5	12.5	12.5	15	15	15	15	17.5	17.5	17.5	20	20
Shut Off Dynamic Head (meters)	12	25	45	70	25	45	70	100	45	70	100	45	70
Water output * (Liters per day)	11,13,750 (from a total head of 10 meters)	5,51,250 (from a total head of 20 meters)	3,93,750 (from a total head of 30 meters)	2,36,250 (from a total head of 50 meters)	6,61,500 (from a total head of 20 meters)	4,72,500 (from a total head of 30 meters)	2,83,500 (from a total head of 50 meters)	1,89,000 (from a total head of 70 meters)	5,51,250 (from a total head of 30 meters)	3,30,750 (from a total head of 50 meters)	2,20,500 (from a total head of 70 meters)	6,30,000 (from a total head of 30 meters)	3,78,000 (from a total head of 50 meters)

* Water output figures are on a clear sunny day with three times tracking of SPV panel, under the “Average Daily Solar Radiation” condition of 7.15 kWh/ sq.m. on the surface of PV array (i.e. coplanar with the PV Modules).

Notes:

1. Suction head, if applicable, minimum 7 meters.
2. For higher or lower head / PV capacity, or in between various models; water output could be decided as per the clause 4 (i.e. Performance Requirements) specified earlier.
3. If submersible pumps are used in lieu of surface pumps, the water output must match that of the surface pumps as specified in this table.

ANNEXURE – V (CONTD.)

Indicative Technical Specifications of Shallow Well (Surface) Solar Pumping Systems with A.C. Induction Motor Pump Set

Description	Model-27	Model-28	Model-29	Model-30	Model-31	Model-32	Model-33	Model-34
PV array (Wp)	18000	18000	20250	20250	20250	22500	22500	22500
Motor Pump-set capacity (HP)	20	20	22.5	22.5	22.5	25	25	25
Shut Off Dynamic Head (meters)	100	150	70	100	150	70	100	150
Water output * (Liters per day)	2,52,000 (from a total head of 70 meters)	1,62,000 (from a total head of 100 meters)	4,25,250 (from a total head of 50 meters)	2,83,500 (from a total head of 70 meters)	1,82,250 (from a total head of 100 meters)	4,72,500 (from a total head of 50 meters)	3,15,000 (from a total head of 70 meters)	2,02,500 (from a total head of 100 meters)

* Water output figures are on a clear sunny day with three times tracking of SPV panel, under the “Average Daily Solar Radiation” condition of 7.15 kWh/ sq.m. on the surface of PV array (i.e. coplanar with the PV Modules).

Notes:

1. Suction head, if applicable, minimum 7 meters.
2. For higher or lower head / PV capacity, or in between various models; water output could be decided as per the clause 4 (i.e. Performance Requirements) specified earlier.
3. If submersible pumps are used in lieu of surface pumps, the water output must match that of the surface pumps as specified in this table.

ANNEXURE – V (CONTD.)

Indicative Technical Specifications of Solar Deep well (submersible) Pumping Systems with A.C. Induction Motor Pump Set

Description	Model-1	Model-2	Model-3	Model-4	Model-5	Model-6	Model-7	Model-8	Model-9	Model-10	Model-11	Model-12	Model-13	Model-14
PV array (Wp)	1200	1800	3000	3000	3000	4800	4800	4800	6750	6750	6750	9000	9000	9000
Motor Pump-set capacity (HP)	1	2	3	3	3	5	5	5	7.5	7.5	7.5	10	10	10
Shut Off Dynamic Head (meters)	45	45	45	70	100	70	100	150	70	100	150	70	100	150
Water output * (Liters per day)	42000 (from a total head of 30 meters)	63000 (from a total head of 30 meters)	105000 (from a total head of 30 meters)	63000 (from a total head of 50 meters)	42000 (from a total head of 70 meters)	100800 (from a total head of 50 meters)	67200 (from a total head of 70 meters)	43200 (from a total head of 100 meters)	141750 (from a total head of 50 meters)	94500 (from a total head of 70 meters)	60750 (from a total head of 100 meters)	189000 (from a total head of 50 meters)	126000 (from a total head of 70 meters)	81000 (from a total head of 100 meters)

* Water output figures are on a clear sunny day with three times tracking of SPV panel, under the “Average Daily Solar Radiation” condition of 7.15 kWh/ sq.m. on the surface of PV array (i.e. coplanar with the PV Modules).

Notes:

1. Suction head, if applicable, minimum 7 meters.
2. For higher or lower head / PV capacity, or in between various models; water output could be decided as per the clause 4 (i.e. Performance Requirements) specified earlier.
3. If submersible pumps are used in lieu of surface pumps, the water output must match that of the surface pumps as specified in this table.

ANNEXURE – V (CONTD.)

Indicative Technical Specifications of Solar Deep well (submersible) Pumping Systems with A.C. Induction Motor Pump Set

Description	Model-15	Model-16	Model-17	Model-18	Model-19	Model-20	Model-21	Model-22	Model-23	Model-24	Model-25	Model-26	Model-27	Model-28
PV array (Wp)	11250	11250	11250	11250	13500	13500	13500	13500	15750	15750	15750	15750	18000	18000
Motor Pump-set capacity (HP)	12.5	12.5	12.5	12.5	15	15	15	15	17.5	17.5	17.5	17.5	20	20
Shut Off Dynamic Head (meters)	100	150	180	225	100	150	180	225	100	150	180	225	150	180
Water output * (Liters per day)	157500 (from a total head of 70 meters)	101250 (from a total head of 100 meters)	95625 (from a total head of 120 meters)	75375 (from a total head of 150 meters)	189000 (from a total head of 70 meters)	121500 (from a total head of 100 meters)	114750 (from a total head of 120 meters)	90450 (from a total head of 150 meters)	220500 (from a total head of 70 meters)	141750 (from a total head of 100 meters)	133875 (from a total head of 120 meters)	105525 (from a total head of 150 meters)	162000 (from a total head of 100 meters)	153000 (from a total head of 120 meters)

* Water output figures are on a clear sunny day with three times tracking of SPV panel, under the “Average Daily Solar Radiation” condition of 7.15 kWh/ sq.m. on the surface of PV array (i.e. coplanar with the PV Modules).

Notes:

1. Suction head, if applicable, minimum 7 meters.
2. For higher or lower head / PV capacity, or in between various models; water output could be decided as per the clause 4 (i.e. Performance Requirements) specified earlier.
3. If submersible pumps are used in lieu of surface pumps, the water output must match that of the surface pumps as specified in this table.

ANNEXURE – V (CONTD.)

Indicative Technical Specifications of Solar Deep well (submersible) Pumping Systems with A.C. Induction Motor Pump Set

Description	Model-29	Model-30	Model-31	Model-32	Model-33	Model-34	Model-35	Model-36	Model-37	Model-38	Model-39
PV array (Wp)	18000	18000	20250	20250	20250	20250	20250	22500	22500	22500	22500
Motor Pump-set capacity (HP)	20	20	22.5	22.5	22.5	22.5	22.5	25	25	25	25
Shut Off Dynamic Head (meters)	225	300	150	180	225	300	375	180	225	300	375
Water output * (Liters per day)	120600 (from a total head of 150 meters)	90000 (from a total head of 200 meters)	182250 (from a total head of 100 meters)	172125 (from a total head of 120 meters)	135675 (from a total head of 150 meters)	101250 (from a total head of 200 meters)	81000 (from a total head of 250 meters)	191250 (from a total head of 120 meters)	150750 (from a total head of 150 meters)	112500 (from a total head of 200 meters)	90000 (from a total head of 250 meters)

* Water output figures are on a clear sunny day with three times tracking of SPV panel, under the “Average Daily Solar Radiation” condition of 7.15 kWh/ sq.m. on the surface of PV array (i.e. coplanar with the PV Modules).

Notes:

1. Suction head, if applicable, minimum 7 meters.
2. For higher or lower head / PV capacity, or in between various models; water output could be decided as per the clause 4 (i.e. Performance Requirements) specified earlier.
3. If submersible pumps are used in lieu of surface pumps, the water output must match that of the surface pumps as specified in this table.

Guidelines on Testing Procedure for Solar Photovoltaic Water Pumping System

1 SCOPE

These Guidelines lays down basis for the testing set up and testing procedures for Solar Photovoltaic (SPV) water pumping systems. The SPV water pumping system covered are centrifugal pumps of all types from 1HP (0.75 kW) to 25 HP (18.75 kW).

2 REFERENCE STANDARDS

The Indian and IEC Standards listed at Annex A contain provisions which, through reference in this text, constitute provision of this standard. The latest editions of the indicated standards should be considered.

3 DEFINITIONS OF SYSTEMS AND PARAMETERS

3.1 Systems

3.1.1 *Stand-Alone Solar PV Water Pumping System*

A Solar PV Water Pumping System in stand-alone operation is neither connected to the grid nor to the battery bank and is comprised mainly of the following components and equipment:

PV Modules, cabling, controller, motor pump-set, and hydraulic piping. The combination of all these components shall be unique for different capacities. Any change in combination will be treated as a different model of pumping system.

3.1.2 *Motor-Pump Set*

The Motor-pump set consists of the pump (centrifugal pump) and the driving motor.

3.1.3 *Controller*

The controller converts the DC power (DC voltage & Current) of the PV array into a high or low DC voltage power, or converts this DC power into single -phase or multi-phase alternating-current power (voltage or alternating current) suitable for driving the motor of Motor-pump set.

NOTE: - The Controller may also include equipment for MPPT, monitoring, metering and for protection purposes.

3.2 Parameters

Following parameter shall be referred during testing of SPV pumping system:

Table 1 . Parameters		
Parameter	Symbol	Unit
(1)	(2)	(3)
Array voltage (DC)	V_a	V
Array current (DC)	I_a	A
Array open circuit voltage (DC)	V_{oc}	V
Array short circuit current (DC)	I_{sc}	A
Array maximum power point voltage(DC)	V_{mpp}	V
Array maximum power point current (DC)	I_{mpp}	A
Pressure as measured	p	kg/cm ²
Flow rate	Q	Lps /Lpm /m ³ /h
Motor voltage DC or AC	V_m	V
Motor current DC or AC	I_m	A
Motor voltage (multi-phase AC)	V_{rms}	V
Motor current (multi-phase AC)	I_{rms}	A
Power factor	$\cos\phi$	-
AC frequency (or DC switching frequency)	F	Hz
Motor speed	N	Min ⁻¹
Radiation	E_e	W/m ²
Temperature	T	°C

4 TEST SETUP

4.1 Test Set-Up

Illustration(s) of test set-ups are shown in Figure 1 & Figure 2, and a block diagram of required test set-up is shown in Figure 3. All test set-ups shall conform to applicable model test set-ups referred to above and the water level in the sump well, locations the of throttle valve, flow meter and pressure gauge/sensor connections as indicated in the test set-up(s) shall conform to Figure 1, Figure 2 & Figure 3 accordingly.

4.2 Precautions for Test Setup:

Before initiating testing of the SPV pump the following precautions must be followed:

- i) In case of a direct coupled pump-set, proper alignment of the input pipe, output pipe and sensors shall be ensured.
- ii) Air tightness in suction line shall be ensured and the general layout of the system pipe work should be designed to avoid airlocks.
- iii) The offset pipe of suction line shall either be horizontal or inclined upward towards the pump and shall never be inclined downward towards the pump to avoid air trapping.
- iv) For the delivery head, a pressure gauge/sensor shall be connected to the delivery line with tapping as shown in Figures 1 or 2 or 3. The tapping shall be flush with the inside of the pipe and shall have its axis at right angles to the direction of flow. The pipe set up between the pump outlet and the pressure sensor should be the same diameter as the manufacturer's outlet fitting. Sensor/gauge may be connected to the tapping point through a flexible hose.
- v) Preferably, a Digital Pressure sensor/gauges of suitable range need to be used for the measurement of head. Care shall be taken to eliminate any leaks in the connecting pipes and to avoid the trapping of air in the connecting pipe or hose.
- vi) It is assumed that over the normal operating range of the pump, the pressure drop due to frictional losses between the pump outlet and the pressure sensor will be negligible and the kinetic energy component of the water at the pump outlet will be small compared to the increase in potential energy due to the increased pressure across the pump.
- vii) For instantaneous performance testing, pressure can be sustained by means of a simple gate valve in which backpressure is sustained by restricting the flow. An automatic control valve(s) may be used to sustain a constant upstream pressure. Pressure may also be sustained by means of a pre-pressurized air chamber operating with a pressure maintaining valve at the outlet. A real water column may also be used.
- viii) A good quality digital flow meter with electrical output linearly proportional to flow rate shall be connected at the other end of the delivery pipe. The distance between the auto control valve and flow meter shall be a minimum of 1.5 meters to ensure the laminar flow of water.
- ix) After flow meter the end of the discharge pipe should be beneath the water surface to prevent splashing. This could cause a mixed water / air bubbles fluid entering the pump inlet and affecting its proper operation. If so then a vertical baffle or a similar arrangement shall be inserted in the tank between the pump intake and the return pipe such that water does not make any splash and avoid any bubbles when spread to the bottom of tank to reach the input pump. In this way any small bubbles will be excluded, as they will remain near the surface. Alternatively, a large pipe can be placed around the pump with its top breaking the surface and an arch cut in its base to allow water entry.

4.3 Priming Arrangement

A non-return valve/ foot valve shall be used in suction line, further it may also require a suction pipe need to be filled with water for priming purpose in case of surface pumps.

4.4 PV Module Array Structures:

For testing the SPV pump using the actual solar array, outdoor PV array structures with different module mounting capacities (4,6,8,10, etc.) should be used. The modules are mounted on the structures with a tracking facility to optimize irradiance, power output and accordingly, the total quantity of water pumped in a day.

4.5 Sun Simulator PV Module Tester:

To estimate the wattage of the PV modules under STC, a high precision (at least class AAA as per IEC 60904-9) sun simulator module tester is required in the pump testing lab.

Alternatively, all PV modules should have STC testing certificate from an NABL accredited test laboratory and the date of testing should not be older than a year. In the STC testing, if the module is found degraded, the degraded data should be used.

4.6 Simulator (Electrical) Testing

Ideally, the SPV pump should be tested as per the site conditions where it is designed to operate. The details of outdoor testing are discussed in the next sessions. However, for testing under simulated conditions, a programmable Solar PV (SPV) array simulator capable of simulating a given solar PV array configuration (i.e., the number of modules, the type and the series / parallel combination), site radiation and temperature conditions shall be required for laboratory. Measurement equipment with acceptable accuracy and precision shall be used for the detection and data logging of the parameters listed in Table 2.

Table 2 - Core Parameters to be Measured and Recorded			
Parameter	Symbol	Unit	Measurement Uncertainty
(1)	(2)	(3)	(4)
SPV Array voltage	V_a	V	≤1 percent
SPV Array current	I_a	A	≤1 percent
Pressure/head as measured	p	Kg/cm ²	≤2 percent
Flow rate	Q	lps	≤2 percent
Solar irradiance	E_e	W/m ²	≤2 percent

4.7 Sump Well (Hydraulic Testing)

For the performance testing of SPV pumps a sump well with sensors for sensing, monitoring and recording of pump parameters will be required. The details of the resources required are given below:

- a) Water tank/sump of required dimensions,
- b) PV Modules, Controller, Motor-pump set, and Other Accessories (Test Sample)
- c) Pressure transducer with data logging system
- d) Flow Meter with data logging system
- e) Suction pipe(s) (if applicable)
- f) Discharge pipe(s)
- g) Pyranometers and Temperature sensors with data logging system
- h) Auto control valves
- i) SPV array Simulator(s) for simulation of module arrays for testing
- j) SPV array for realistic testing
- k) Structure for mounting modules for realistic condition testing
- l) AAA class Sun simulator for testing of modules performance at STC

Refer to the block diagram in Figure 3.

4.8 Constant Head Requirement

Dynamic head variation during test shall be within limit as specified in column 2 of table 3 and the allowable variation in arithmetic average (from the start of flow point to the end of flow point refer to figure 5) of the dynamic head shall be within value specified in column 3 of table 3. Any data with head variation during the test beyond the limit specified in column 2 of table 3 shall be treated as garbage data and shall not be considered in calculations of daily water output.

Table 3 - Allowable variation in arithmetic average of dynamic head		
Required Dynamic head in (meters)	Allowable variation in dynamic head during test	Allowable variation in arithmetic average of dynamic head
(1)	(2)	(3)
10	$\pm 15 \% = \pm 1.5$ meter	± 0.5 meter
20	$\pm 10 \% = \pm 2$ meter	± 0.5 meter
30	$\pm 10 \% = \pm 3$ meter	± 0.7 meter
50	$\pm 8 \% = \pm 4$ meter	± 0.8 meter
70	$\pm 7 \% = \pm 4.9$ meter	± 0.8 meter
100	$\pm 7 \% = \pm 7$ meter	± 1 meter
120	$\pm 7 \% = \pm 8.4$ meter	± 1 meter
150	$\pm 7 \% = \pm 10.5$ meter	± 1 meter
200	$\pm 7 \% = \pm 14$ meter	± 1 meter
250	$\pm 7 \% = \pm 17.5$ meter	± 1 meter

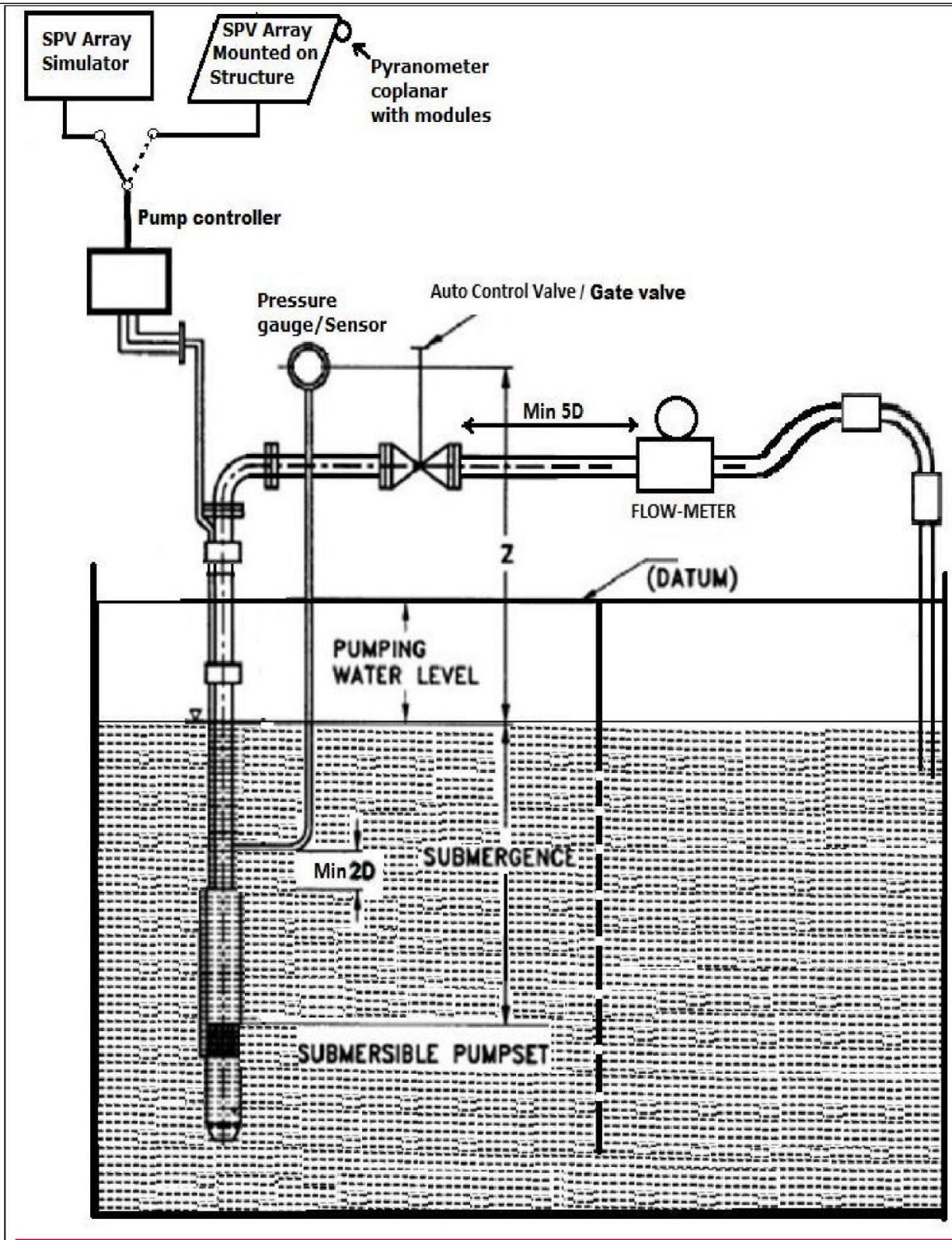

FIGURE 1. TYPICAL TEST SET-UP FOR SUBMERSIBLE SPV WATER PUMP-SET

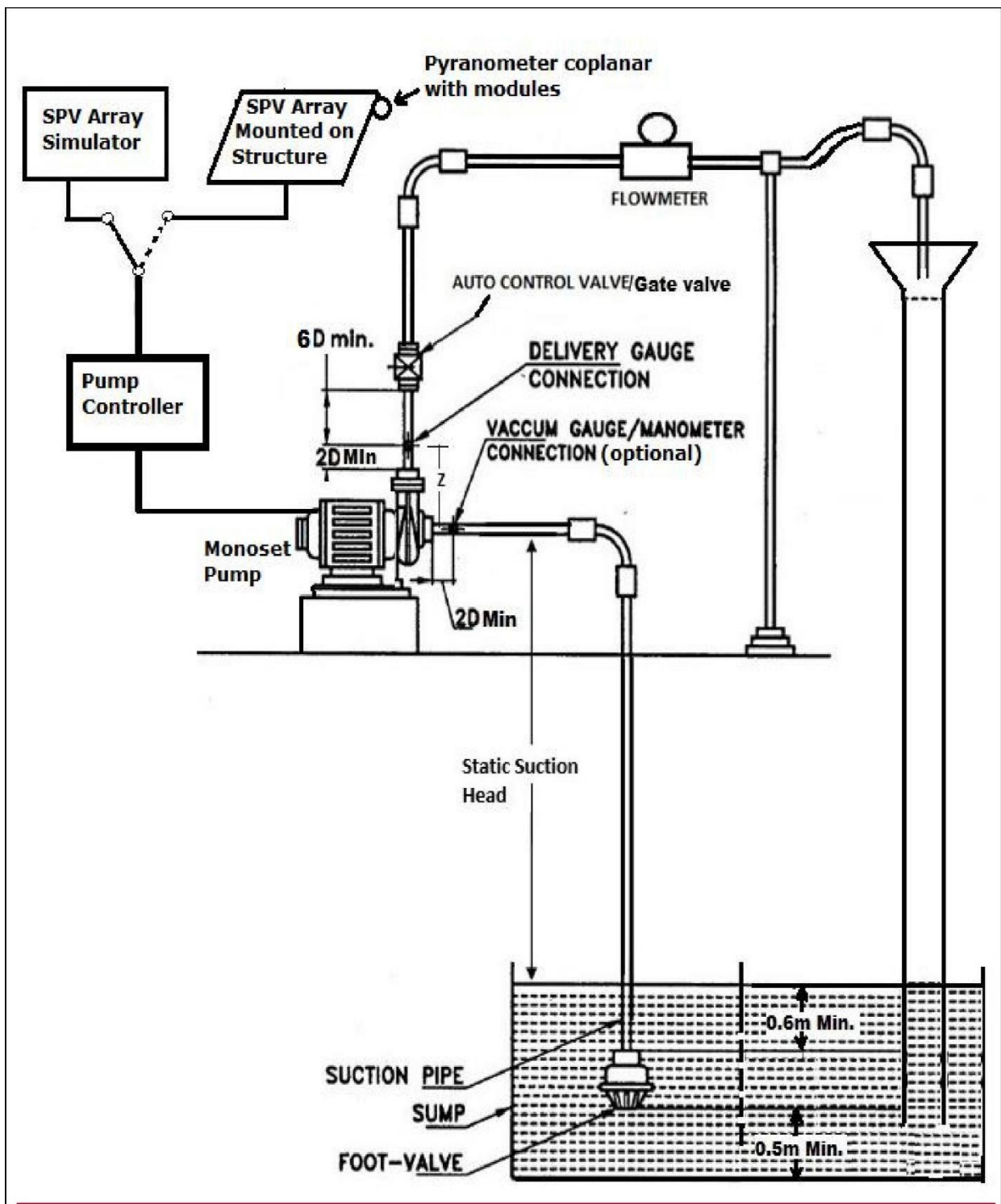

FIGURE 2 . TYPICAL TEST SET-UP FOR SPV SURFACE/MONO-BLOCK WATER PUMP SET

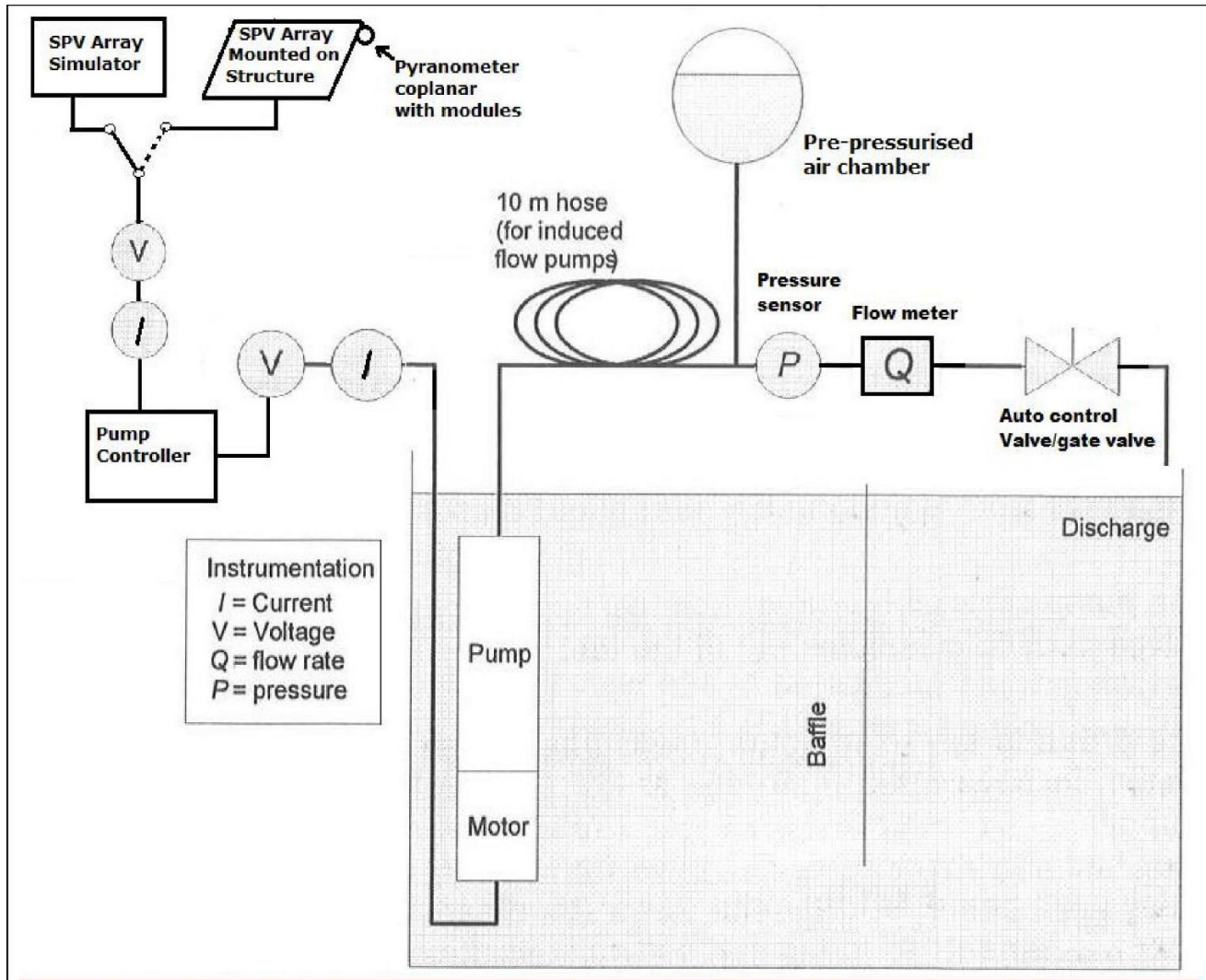

FIGURE 3 . BLOCK DIAGRAM OF TEST SETUP FOR SUBMERSIBLE PUMP-SET

5. TEST PROCEDURE FOR PERFORMANCE EVALUATION OF SPV PUMPING SYSTEM:

There are three major profiles to be completed for comprehensive certification and qualification of a sample SPV water pump as per this standard. Two steps correspond to two simulation profiles, Hot & Cold. The third step corresponds to actual outdoor conditions testing using natural sun radiation. The SPV water pump sample should attain or exceed the qualification benchmarks set by MNRE for the specified model & design, in all three profiles. Before executing the three profiles testing, it is necessary to conduct the following protections test on the sample:

1. **Dry running:** System must shut down within one minute/manufacture specification in dry running condition (when the water level goes below pump inlet).
2. **Open circuit:** System should not operate if any phase become open circuited, the controller shall be tripped within one minute/manufacture specified time.
3. **Short circuit:** System should not operate if any two or all three-phase short circuited.

4. **Reverse polarity:** System should not malfunction if the polarity of input power is reversed.
5. **Under Voltage:** System shall not operate if the terminal voltage goes below the limit specified by the manufacturer.
6. **Surge Protection:** A surge protection device (SPD) shall be installed on the input side.

The performance testing of the SPV Pumping System for the three procedures are discussed in the following sections:

5.1 Simulator Methods:

Simulation methods are the easiest and fastest way of estimating SPV pump performance. However, in these methods actual PV array is not used, instead a PV array simulator is used. Here, a Programmable SPV array simulator capable of generating power output equal to actual SPV array under the given radiation and temperature conditions for a given SPV array configuration (i.e., the number of modules, the type and the series / parallel combination) will be used. Although any radiation & temperature can be created, for the purpose of testing, two conditions one Hot summer day conditions (hot profile) and the other Winter day conditions (cold profile) shall be used.

Hot & Cold Profiles:

The typical Hot & Cold day profiles are shown in Figure 4. These profiles of full-day Solar irradiance and temperature shall be loaded in PV array simulator, sequentially one after the other. The simulator output is connected to the motor & pump through the pump controller and

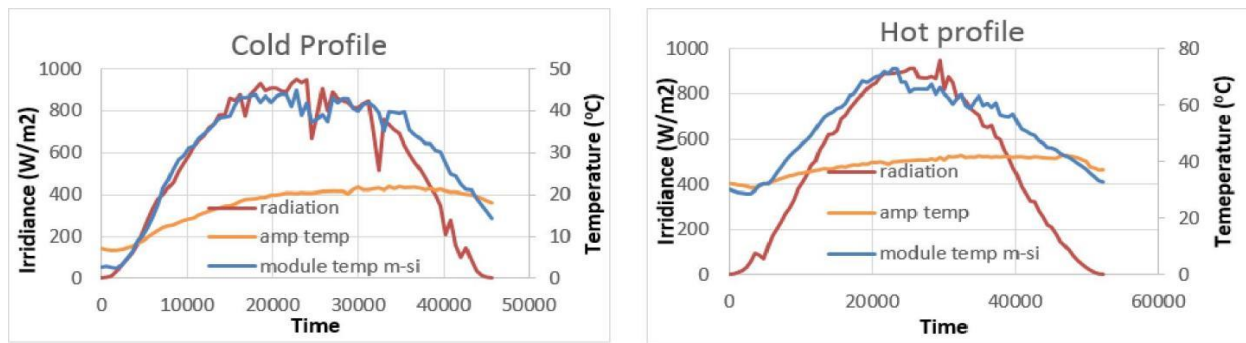

the profiles are run-on a real-time basis. The performance parameters as given in table 2 are collected every minute for the entire duration of run time (per day). The total water output and output in liters /watt STC/ day can be estimated at desired constant head / dynamic head for complete duration of profiles. The temperature coefficient of power shall be derived from the IEC 61215/IS 14286 standard test report for the module supplied with the pump of the same model.

FIGURE 4. TYPICAL SOLAR RADIATION HOT AND COLD PROFILE

Note: Per second data for hot and cold profile may be downloaded from MNRE website using the following link: - <https://mnre.gov.in/solar/standard-specs-cost>

5.2 Outdoor Condition using sun radiation:

For operating the motor-pump set using the actual PV array, an array as per the Motor-pump set HP capacity is to be designed. The STC wattage of all the PV modules is measured first, as per IEC 60904-1/ IS 12762-1 or clause number 11.6 of IEC 61215/ clause number 10.6 IS 14286. The modules will then be installed on the structures, both in series and parallel combinations, as required, are connected and a designed PV module array is created. The array output is connected to the Motor & Pump through the pump controller.

The Per day water output test has to be performed at desired constant dynamic head for the complete day from dawn to dusk (sunrise to sunset). Irradiance shall be measured at coplanar to modules. Tracking may be done manually or automatically. Total flow shall be corrected at reference Average Daily Solar Radiation of 7.15 kWh/m² on the surface of SPV array (i.e., coplanar with the SPV Modules). Results of the SPV pumping system obtained under outdoor conditions shall be compared with data supplied by the applicant and also from the results obtained through simulator testing to assess the performance of the system.

NOTE: -

- Handle PV modules carefully during installation.
- PV modules should be free of dirt (sand, bird droppings etc.,) during the test.
- Install PV modules in shadow free and accessible area.
- Tracking shall be minimum of three times a day for maximum performance
- Pyranometer should be mounted co-planer with SPV modules.

Recording, measurement & logging of flow for the period of hot profile, cold Profile and Realistic condition needs to be done.

5.3 Remote Monitoring System Verification

Provision for remote monitoring of the installed pumps must be made in the controller through an integral arrangement and it should be capable of providing live status/parameters through web portal.

6 MEASUREMENTS AND APPARATUS

6.1 Solar Radiation Measurement

Solar radiation at surface co-planar with the Module shall be measured using a pyranometer. Response time of the pyranometer should not be more than 15 seconds. The interval between two readings should not be more than one minute for the calculation of average daily solar radiation.

6.2 Measurement

of Head 6.2.1

Delivery Head

Digital pressure gauge/sensor shall be used, also a data logging system must be used for calculation of average head through day. The interval between the two readings should not be more than one minute for calculating average head. Accuracy for pressure sensor shall be within ± 0.5 percent.

6.2.2 Suction Lift

Suction head shall be kept constant by maintaining a constant vertical distance between sump water level and the centre of the Pump's impeller. Correction in head shall be applied as per atmospheric pressure at the testing place.

Distance measuring scale or laser-based sensors can also be used for suction head measurement.

6.3 Measurement of Rate of Flow

A good quality Magnetic flow-meter of minimum 0.5% accuracy class shall be used for flow measurement, data logging system shall be used for calculating cumulative water volume throughout the day. The maximum flow rate of flowmeters should be at least 1.5 times the maximum flow rate of pumps. Instrument can be selected as per 3.2 of IS 11346. The interval between two readings should not be more than one minute for the calculation of cumulative flow. The accuracy of flowmeters shall be within ± 0.5 percent.

7 CALIBRATION OF APPARATUS

All measuring instruments have to be calibrated periodically as per requirement.

8 STEP-WISE TEST PROCEDURE

8.1 Per Day Water Flow Test of Submersible Pumps

- a) Install the Pump-set as per Figure 1.
- b) Connect Pump-set with controller as per manufacturer instruction
- c) Use Solar PV Array Simulator Or actual output from SPV array, for testing the pump-set at the given profile.
- d) Connect controller with SPV array Simulator or with actual SPV array output as per requirement of profile

- e) Input STC performance data of each module in the array into simulator and invoke the desired profile and run the same.
- f) For a realistic condition test, make an array by mounting all SPV modules on structure(s) by connecting modules in series or parallel as per requirement.
- g) Start the controller after connecting it with the array or array simulator.
- h) Use a head control valve or pre-pressurize tank to maintain constant desired dynamic head.
- i) Tabulate the readings in Table 2 and the recording interval shall be less than or equal to 1 minute.

8.2 Per Day Water Flow Test of Surface Pumps

- a) The pump-set should be installed as demonstrated in Figure 2
- b) Maintain height to get desirable static suction head as per requirement
- c) Install foot valve or non-return valve as per manufacturer instructions; and
- d) Follow steps (b) to (i) of para-No. 8.1

9 OBSERVATIONS

The following observations of the complete day profile shall be recorded in a test record sheet. The following observations shall be used to derive pump characteristics:

- a) Instantaneous Solar irradiation (W/m^2), pyranometer reading
- b) Delivery gauge/sensor readings
- c) Suction gauge/sensor readings / Distance between water level to impeller eye, (if applicable)
- d) Gauge distance correction factor, Z
- e) Calculate cumulative daily solar radiation on surface co-planar with solar modules (kWh/m^2),
- f) Calculate total water discharge in a day at the desirable constant head (Litres per Day)
- g) Water output per day per watts peak (Litres/Wp)

10 COMPUTATION OF TEST READINGS

10.1 Computation of Total Head for Surface (Mono-set) Pump

$$\text{Total Head } H = H_{SSL} + H_d + Z + ((V_d^2 - V_s^2) / 2g)$$

H_{SSL} = Total Static suction Lift in meters of water column (measured by calibrated measuring tape or any distance measuring sensors)

H_d = Delivery gauge/sensor reading in meters of water column

Z = Gauge distance correction factor for delivery gauge centre and inlet pipe centre in meters (refer figure 2). If the delivery gauge centre is below the inlet pipe centre, Z should be subtracted from the delivery gauge reading and if the delivery gauge centre is above inlet pipe centre, should be added to the delivery gauge reading; the gauge distance correction factor shall never be applied to the suction vacuum gauge or mercury manometer reading irrespective of their positions:

V_d = Velocity at delivery gauge/sensor connection, m/s;

V_s = Velocity at suction gauge/sensor connection, m/s; and g = Acceleration due to gravity in m/s².

The Total Static Suction Lift in surface pump (H_{SSL})

H_{SSL} = Height in meter from water level to impeller + Altitude correction in meter + water temperature correction in meter.

10.1.1 Correction for Altitude

Barometric pressure shall be recorded at the test place. The difference between atmospheric pressure at the test place and 10.33 mWC (that is atmospheric pressure at MSL) shall be deducted from Static suction lift.

10.1.2 Correction for Water temperature

Static suction lift specified in the below Table shall be increased or reduced as given below when the water temperature is below or above 33°C.

Table 4 - Correction for water temperature

Hourly Average of Water Temperature °C	Vapour pressure mWC	Correction in Static suction lift above and below 33°C water temperature mWC
10	0.13	+ 0.39
15	0.18	+ 0.34
20	0.24	+ 0.28
25	0.33	+ 0.19
30	0.43	+ 0.09
33	0.52	0.00
35	0.58	- 0.06
40	0.76	- 0.24
45	1.00	- 0.48
50	1.28	- 0.76

Suction head shall be adjusted minimum 3 times in a day as per average water temperature and barometric pressure, by adjusting water level of tank.

Following formula can also be used on behalf of table

$$4 y = -0.0007 x^2 + 0.0130 x + 0.3079$$

Where

y = Correction in Static suction lift

x = Average water temperature.

10.2 Computation of Total Head for Submersible Pump-sets

Total head $H = H_d + Z + ((V_d^2) / 2g)$ Where:

H_d = Delivery gauge/sensor reading in meters of water column;

Z = Gauge distance correction factor for delivery gauge. Distance between gauge/sensor center to tank water level (refer figure 1).

V_d = Velocity at delivery gauge/sensor connection in m/s;

g = Acceleration due to gravity in m/s^2 .

10.3 Total Water Per-Day

Total water output per day shall be calculated by Integration (Sum) of flow rate with respect to time. Integration shall start from the time when pump set achieves desired constant head in morning time (start point refer figure 5) and ends at the time when pump set is unable to achieve desired constant head in evening time (End point refer figure 5).

In case if Average Daily Solar Radiation found less than requirement then test shall be performed on next sunny day.

10.4 Water Output Per Day Per Watt Peak

Water output per day per watts peak (liter/Wp) = Water output (Liters) per day at specified head / Array STC power in watts-peak

10.5 Cumulative Daily Solar Radiation

Cumulative Solar Radiation (kWh/m^2) in a day = Average of instantaneous irradiance reading from Dawn to Dusk (kW/m^2) X period of time in hours.

This can be obtained through time weight summation of pyranometer readings.

Dawn = Time of sunrise when irradiance become positive from zero value.

Dusk = Time of sunset when irradiance become zero from positive value.

10.6 Mismatch in maximum power at STC among modules of array

The mismatch shall be calculated as under:

$$\% \text{Power mismatch in array} = \frac{(P_{\text{Max}} - P_{\text{Min}})}{(P_{\text{Max}} + P_{\text{Min}})} \times 100$$

P_{Max} = Maximum power among modules in array

P_{Min} = Minimum power among modules in array

10.7 Efficiency of Array

The efficiency of Array = The power output from array / (total area of modules in m^2 X Sun radiation in watts/m^2)

10.8 Fill Factor of Array

Fill factor of Array = This has to be measured using a PV array tester. This depends on the overall series resistances and shunt resistances of modules in the array.

10.9 Output Voltage of Array

Output Voltage of Array = Sum of voltages of modules in series

In parallel connected module strings, the lowest voltage generating strings will set the voltage.

10.10 Output Current of Array

Output Current of an Array = Sum of currents of the parallel strings in the array. The output current of a string is controlled by the lowest current generating module.

10.11 Output Power of Array

Output Power of Array = Sum of power of all modules- mismatch loss This can be measured by PV array tester.

11 EXAMPLES:

11.1 Total per day flow

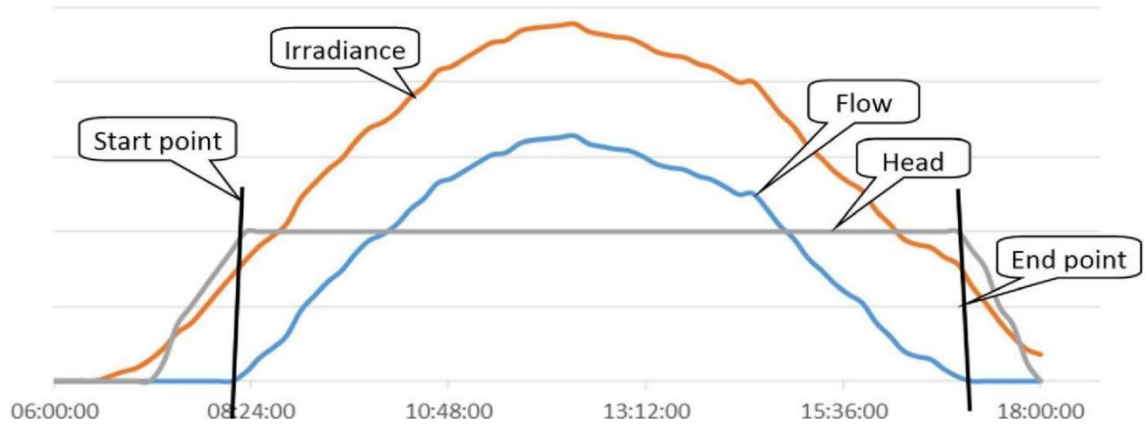

FIGURE 5- TYPICAL GRAPH FOR UNDERSTANDING CALCULATION

If pump achieved constant head at 8:15:30 AM (Start point in figure 5) and in evening Pump unable to keep constant desired head at 17:45:30 PM (End point in figure 5). Flow rate in lps is recorded from 08:15:30 AM to 17:45:30 PM (start point to end point) If the average discharge calculated is 3.55 lps, then the total flow will be

$$\begin{aligned}\text{Total duration of flow} &= \text{End Time} - \text{Start time} \\ &= 17:45:30 - 8:15:30 \\ &= 9 \text{ h: } 30 \text{ m: } 0 \text{ s}\end{aligned}$$

Total duration from start to end in seconds:

$$= (9 \times 3600) + (30 \times 60) + (0 \times 1) = 34200 \text{ seconds}$$

Total discharge per day in liters = Average flow in lps x Total no of seconds

$$= 3.55 \times 34200 = 121410 \text{ liters}$$

For a realistic test, correct the total flow at reference Average Daily Solar Radiation as specified in MNRE specifications.

12 TEST REPORTS

In order to have uniformity, the test reports issued by the Labs shall use a common format developed by NISE. The test report shall be issued only in the name of applicant and shall clearly indicate that whether the Solar PV water pumping system qualify as per MNRE specifications or not along with the details. A soft copy of test report shall also be provided to the applicant and shall be made available on web-portal of test lab, which may be accessed by the implementing agencies for verifying the authenticity of the report.

13 USE OF OTHER BRAND OF SOLAR MODULES

In case a test lab has tested and issued an approval certificate for a particular model of SPV pumping system using a particular model of SPV Modules, the applicant may use different models of SPV Modules for the same model of SPV pumping system without going for re-testing of complete SPV pumping system with a different model of SPV Modules, provided the test lab certifies that the qualitative characteristics of newly proposed model of SPV Module are not inferior to the SPV Module with which the SPV pumping system was tested. In addition, the total wattage capacity of the Solar Array with the proposed model of SPV Modules shall be equal or higher than the wattage capacity specified by the MNRE for that model of SPV pumping system. The proposed model of SPV module shall also meet the following conditions:

- Solar Array Maximum voltage V_{mpp} with other brand module shall be within $\pm 2\%$ of earlier module.
- Modules Efficiency and Fill Factor shall qualify the minimum requirement of MNRE specifications
- Module to module mismatch in an array shall meet the MNRE specifications.
- SPV module shall follow the quality control order issued by MNRE from time to time.

14 LABS AUTHORISED FOR SOLAR PUMP TESTING

- Any lab accredited by NABL for testing of solar PV water pumping system as per MNRE specifications and testing procedure, and The National Institute of Solar Energy are authorized to issue approval certificate on successful testing of a solar PV water pumping system.
- Soft copy of test report shall be made available to implementing agencies on request basis.
- Logged data for Head, flow & radiation shall be preserved by laboratory at-least for 1 year.

LIST OF REFERRED STANDARD

IS No.	Title
17018-1 : 2018	Solar Photovoltaic Water Pumping System Part 1 Centrifugal Pumps — Specification
14286 : 2010	Crystalline Silicon Terrestrial Photovoltaic (PV) Modules — Design Qualification and Type Approval
3043 : 1987	Code of Practice for Earthing
5120 : 1977	Technical requirements for rotodynamic special purpose pumps (first revision)
11346 : 2003	Tests for Agricultural and Water Supply Pumps — Code of Acceptance
6603 : 2001	Stainless Steel Bars and Flats
6911 : 2017	Stainless steel plate, sheet and strip
7538 : 1996	Three-phase squirrel cage induction motors for centrifugal pumps for agricultural applications
8034 : 2018	Submersible pump sets - Specification (second revision)
9079 : 2018	Electric Monoset pumps for clear, cold water for agricultural and water supply purposes - Specification (second revision)
9283 : 2013	Motors for submersible pump sets
11346 : 2002	Code of acceptance tests for agricultural and water supply pumps (first revision)
14220 : 2018	Open well submersible pump sets — Specification
14582 : 1998	Single-phase small AC electric motors for centrifugal pumps for agricultural applications
ISO 9905 : 1994	Technical specifications for centrifugal pumps — Class I
IEC 60068-2-6 : 2007	Environmental testing – Part 2-6 Tests – Test Fc: Vibration (sinusoidal)
IEC 60068-2-30 : 2005	Environmental testing – Part 2-30 Tests – Test Db: Damp heat, cyclic (12 + 12h cycle)
IEC 60146-1-1 : 2009	Semiconductor converters - General requirements and line commutated converters Part 1-1 Specification of basic requirements
IEC 60364-4-41 : 2005	Low-voltage electrical installations - Part 4-41: Protection for safety - Protection against electric shock
IEC 60364-7-712 : 2017	Low voltage electrical installations - Part 7-712: Requirements for special installations or locations - Solar photovoltaic (PV) power supply systems
IEC 60529 : 1989	Degrees of protection provided by enclosures (IP Code)
IEC 60947-1 : 2007	Low-voltage switchgear and control gear - Part 1: General rules
IEC 61000-6-2 : 2016	Electromagnetic compatibility (EMC) - Part 6-2: Generic standards - Immunity standard for industrial environments
IEC 61000-6-3:2006	Electromagnetic compatibility (EMC) - Part 6-3: Generic standards -Emission standard for residential, commercial and light-industrial environments
IS/IEC 61683 :1999	Photovoltaic Systems — Power Conditioners — Procedure for Measuring Efficiency
IS/IEC 61730-1 : 2004	Photovoltaic (Photo Voltaic (PV)) Module Safety Qualification Part 1 Requirements for Construction
IS/IEC 61730-2 : 2004	Photovoltaic (Photo Voltaic (PV)) Module Safety Qualification Part 2 Requirements for Testing
IEC 61800-3:2017	Adjustable speed electrical power drive systems - Part 3: EMC requirements and specific test methods
IEC 62109-1:2010	Safety of power converters for use in photovoltaic power systems - Part 1: General requirements
IEC 62305-3:2010	Protection against lightning - Part 3: Physical damage to structures and life hazard
IEC 62458:2010	Sound system equipment – Electro-acoustical transducers - Measurement of large signal parameters

IEC 60904/IS
12762-1

Procedures for the measurement of current-voltage characteristics (*I-V* curves) of photovoltaic (PV) devices in natural or simulated sunlight.

Universal Solar Pump Controller (USPC)

1. Preamble:

The Controller for Solar PV pumping system is the heart and brain of the system. The Solar PV pumping system deployed at huge cost to the farmer and the exchequer for the Government is currently utilised only for half of the days in a year (around 150 days per year) on an average. In order to optimally utilize the solar photovoltaic system that generates the electricity throughout the year during sunshine hours, the controller supplied for installation of solar pumping system should be able to perform several other tasks for agricultural and other needs of a farmer. This will increase the productivity of agriculture sector and income of farmer. With the use of USPC the solar system could be used effectively throughout the year.

2. Technical Specification for Stand Alone Application

The USPC with SPV modules and structure can be used for agrarian applications such as water pumping, apple grading and polishing system, wheat (grain) flour grinding machine / aata chakki, cutter/chaff, deep-fridger / cold storage, blower fan for cleaning of grains, heating loads and any other standard voltage (400/415V) three phase motor/equipment of capacity not more than the capacity of Solar PV pumping system. The USPC operation schematic diagram is shown in Fig. 1. Further, the applications are not limited upto the few shown in the figure.

- I. Following table gives specifications of electrical supply from USPC for motors other than the solar pumps. For operating the pump the USPC must follow the MNRE specifications for SPV pumping systems.

Sr No.	Description	Desired requirement
1	Motor Supply Phases	Three phase R-Y-B
2	Rated motor frequency	48-50Hz
3	Frequency operation	0 to 52Hz
4	Rated motor voltage	415V \pm 5%
5	Desired motor operation	Constant V by F or constant motor flux control

- II. Proposed electrical properties of USPC when operating motors other than motor- pump set:

Sr No.	Description	Desired requirement
1	Characteristic of voltages	Pure sinusoidal or Filtered AC output voltage at motor terminal. No PWM pulses allowed at the motor terminal, as it generates pronounced voltage spikes. The USPC output is intended to use for the traditional induction motors based applications which are design for sinusoidal grid supply.
2	THD of motor terminal voltages	Below 3%
3	THD of motor current (in case of balance/linear motor)	Below 5%

4	Balance supply	Three phases should be balanced and no negative sequence components to be allowed
5	Voltage spikes	Recurring or non-recurring voltage spikes more than 620V (peak of 440V AC supply) is not allowed
6	Alarms and Protections	Output voltage low, Output frequency low/high, Low irradiance/PV power, Current overload, Peak Torque

III. Controller should be able to run SPV pumping system as per MNRE specifications as well as any other type of motor of suitable rating, subject to the load characteristics of the equipment in which the motor is used is any of the following:

- a) Constant torque loads
- b) Constant power loads
- c) Quadratic loads
- d) Impact loads
- e) Hydraulic loads

Subject to the maximum torque being not more than 150% of the rated torque of the motor.

IV. To ensure energy efficiency of solar PV system and to maintain reliability of PV installation against aging effect, module mismatch with time, partial shading, etc., the desired USPC properties and configuration should be as follows:

- (a) Static MPPT efficiency of USPC should be equal or more than 98% during operation of 10 to 100% of rated STC PV power, and average MPPT tracking efficiency in the dynamic condition should be greater than 97 % with hot and cold profiles when feeding the water pumping, hydraulic or heating loads, so as to maintain MPPT irrespective of variation in solar energy or irradiance.
- (b) USPC efficiency should be as follows for the operation at 80% rated STC power of the PV array:

Sr No.	SPV pumping system capacity	Controller power efficiency should be more than or equal to
1	3 HP	93.00%
2	5 HP	93.00%
3	7.5 HP	94.00%
4	10 HP	94.50%
5	15 HP	94.50%

- (c) Considering voltage variation over the year due to variation in temperature, irradiance and effect due to ageing, environmental damages to PV panels with time, USPC should have MPPT channels as an integral part of system (or externally connected part) with wide range of input PV voltage for MPPT tracking of the PV panels. Input voltage range variation should be tested as per manufacturer declaration (min, nominal or 90% of the maximum) or if no declaration is made than at least it should be tested as per the table given below:-

Sr No.	Motor Pump set capacity	Input voltage range		
		Minimum	Nominal	Maximum
1	3 HP	(0.85*Vnominal)	Nominal	(1.15*Vnominal)
2	5 HP	(0.85*Vnominal)		(1.15*Vnominal)
3	7.5 HP	(0.85*Vnominal)		(1.15*Vnominal)
4	10 HP	(0.85*Vnominal)		(1.15*Vnominal)
5	15 HP	(0.85*Vnominal)		(1.15*Vnominal)

- V. There should be Mode selection located on control panel of the USPC along with display and user should be able to select either to run motor-pump set of any other application. The software/firmware required to operate these applications must get automatically loaded when an appropriate position of the switch is engaged.
- VI. USPC must have at least four numbers of three phase output cables to feed power to the applications. The output power cable for specific application should get selected automatically upon selection of applications via keypad or via mobile or via remote control connectivity. The manual selector switch should not be used at the output to manage different loads. This is to ensure the hassle-free operation of applications by farmer with adequate safety.

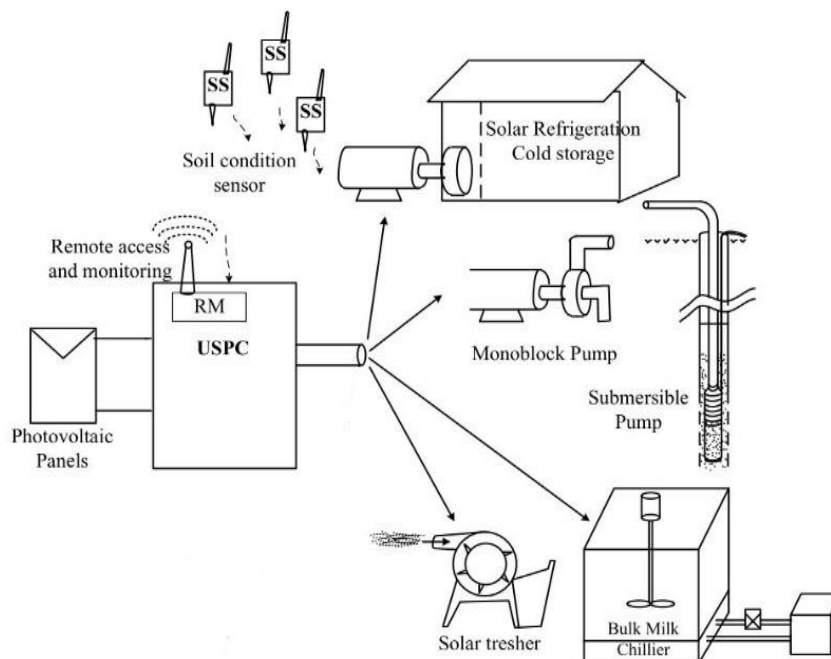

Fig. 1. USPC operation schematic diagram.

VII.USPC based Solar system must be equipped with Remote monitoring and remote fault identification:

- (a) Remote monitoring features should be integral part of solar pump controller and should provide time wise remote monitoring of PV voltage, PV Power, Water output, head, when used in solar pump mode. When operated in farm equipment mode, it should show, PV voltage, PV power, motor voltage, motor current and motor frequency.
- (b) Cumulative energy generation from PV panels for a month, year and 5 years should be provided.
- (c) Remote monitor should show current status of system like On, Off and fault.
- (d) Software associated with remote monitoring should also provide location of SPV pumping system.
- (e) Controller should have support of sufficient Internal memory/ SD card / memory card to support remote monitoring in case of network failure.

USPC must have IP65 protection or must be housed in a cabinet having at least IP65 protection.

Testing Procedure for Universal Solar Pump Controller (USPC)

USPC must be tested in two principle modes:

1. As an offgrid solar pump controller: the testing should be as per MNRE specifications and Test procedure.
2. As a controller to operate motorized farm equipment: The testing should be as described below.

To test the USPC in the second mode the test centres must have standard actual mode suitable for 4 loading modes. The input to the USPC must be from a solar PV simulator using the hot and cold profiles issued by MNRE. Following tests may be performed on USPC driving the agrarian load like Atta Chakki, Chaff Cutter and Deep Freezer under test. The USPC must be able to operate these motors of the attached agrarian load, so that they deliver the rated torque and are able to also operate till 150% of the rated torque for 30 seconds.

S.No .	Test Performed	Expected result	Test Lab Observation	Remarks
1	Application description on screen and selection of applications	LCD screen provided on controller need to shows various applications which can be selected by keypad using up-down and enter key		
2	Mode operation of applications (Automatic: through keypad or remote / Manual: control switches)	Universal Solar Agriculture controller should come with multiple outputs which can be permanently connected to the application by selecting appropriate options for example following applications should automatically started by USPC by appropriate mean such as keypad or remote for selection. (i) Water Pumping (ii) Chaff Cutter (iii) Deep fridge/ Cold Storage (iv) Atta Chakki Manual changeover is not allowed.		
3	Application Specific output (Application specific software)	USPC should have inbuilt individual application specific software to run the agrarian applications other than pumps and output of the controller should be suitable for above mentioned applications		

4	Input PV voltage range Minimum – Voc at STC Nominal – Voc at STC Maximum – Voc at STC				
5	USPC Efficiency measurement in Hot and cold profile should be measured as per BS EN 50530/IEC 62891	Efficiency of the UPSC at minimum VOC			
		Load %	Charge controller eff (%)	Power tracking Efficiency (%)	Overall charge controller efficiency (%)
		10			
		25			
		50			
		75			
		100			
		Efficiency of the UPSC at Nominal VOC			
		10			
		25			
		50			
		75			
		100			
		Efficiency of the UPSC at 90 % of Max VOC			
		10			
25					
50					
75					
100					
Dynamic MPPT Efficiency					
Hot Profile					
Cold Profile					
6	Ripple and distortion at output on full load	Should below 5 % after 25 % loading condition			
7	Measurement of Output voltage waveform	Three phase output with up to 440 V rms pure Sine Wave to be measured at least 4 times between 300W/m ² irradiance and maximum irradiance as per the irradiance profile.	CF value should be provided by lab for voltage and current		
8	Operation at different output from array with all four load types (Array wattage as per MNRE model:	Above.....Watt DC output Should not stop functioning at any load condition. Observation should be recorded.	Power value should be recorded by the lab with all agrarian load	Motor current should be recorded (for torque behavior) It must be almost constant	

	Example 4800 Wp array) At 40% Power At 50% Power At 75% Power At 100% Power		supported by USPC	irrespective of available DC power from array (motor running condition). This is for Impact loading condition (such as Chaff cutter) current variation need to be recorded by laboratory.
9	Operation at different output from array with all four load types (Array wattage as MNRE model: Example 4800 Wp array) At 10 % Power At 25 % Power At 30 % Power	USPC need to run all the agrarian load in variable frequency at the lower irradiance value The load may be increased beyond 150% of rated torque to determine at what level the motor is stalling and stopping and it must trigger 'torque overload' alert. If it goes beyond 150% of the motor rated torque the USPC must trip indicating an 'overload tripping'.	Motor current should be recorded (for torque behavior) as it is a function of V/F ratio controlled by USPC	
10	Total circuit protection observation	<ul style="list-style-type: none"> • Soft Startup, • low radiation protection, • overload protection, • Open circuit protection • Reverse polarity protection 		

Expected output of individual applications must be specify as per their power rating and SPV capacity, such as:

1. kg/hour grinding of atta chakki, and granularity.
2. Volumetric Iceing of cold storage in x hours.
3. Output in terms of kg/hours for a specific capacity grass-cutter.
4. Output must be quantified in terms of rate of volume or weight as above for any other applications.

All the test labs authorised to conduct testing for off-grid solar pumping system as per MNRE specifications may also conduct testing of USPC as per procedure prescribed above and issue testing certificates.